

# The South Eastern Times

Phone: 08 8741 8170 Trades and Classifieds: 1300 666 808

\$2.00 Inc. GST



**Pharaoh on the move**

PAGE 8



**More members needed**

PAGE 9



**Business awards open**

PAGE 12



**Mozzies Dominate**

PAGE 28

## Birthday wishes for a grand lady

There was cause for celebration in Millicent last week, as matriarch of the Williams family Dardanella Williams turned 106.

Born on August 2, 1916, Mrs Williams has lived a long life of love and celebrated the occasion surrounded by her friends and family.

Her loved ones shared stories and fond memories of 'Aunty Dell', who now resides at Boneham Aged Care Services.

Story page 3



Dardanella Williams was surrounded by her loved ones last week as she turned 106.

# Plan for progress

By Elsie Adamo

Wattle Range Council endorsed its new Draft Strategic Land Use Plan at a meeting this week following the consultation.

The new plan will help guide the Council on local land matters until 2047 and looks at all townships within the Wattle Range area.

The plan identified Millicent as the key ser-

vice centre for the district, with 13 key actions to guide the town's land into the future.

### Actions in the plan for Millicent:

- Support the development of Millicent's town centre consistent with the Town Centre Concept Design, including potential residential development which is ancillary to, or does not prejudice the operation of, commercial facilities.

- Support the development of age-friendly housing including Independent Living Units and Residential Aged Care, particularly close to the town centre, including with public realm upgrades.

- Support the development of the railway lands precinct, including seeking a rezoning of the site under the Planning and Design Code.

- Seek to amend the Planning and Design Code to rezone Lake McIntyre to a Zone reflective of its use for recreational purposes and an important space for biodiversity.

- Support, in principle, industrial development in the Strategic Employment Zone to the west of the town.

Continued page 3

SHEDS • ROOFING • FASTENERS • FENCING • GUTTERS • FLASHINGS • DELIVERIES • SALES



STEEL, ROOFING AND FENCING SUPPLIES

*"we do it better on top!"*

FOR ALL YOUR STEEL, ROOFING AND FENCING SUPPLIES

3MP are your one stop shop where your dream space becomes reality.



8733 4394 • accounts@3mp.net.au • 43 Saleyards Road, Millicent





## INSIDE

MOTORING .....	page 14
WEATHER .....	page 15
TV GUIDE.....	pages 16-19
PUZZLES .....	page 20
CLASSIFIEDS .....	page 23
SPORT.....	pages 24-32

## Take the lead

Youth with disability have the opportunity to enrol in the Empowering Able Young Leaders program for a free face-to-face workshop aimed at those aged between 16-30.

Anyone within this age range that identifies as having a disability, chronic illness, being blind, vision impaired or deaf, neurodiverse and/or lived experience of mental health issues is welcome to attend the workshops.

The first of four events is this Saturday, August 13, 10am-2pm at the Millicent Library and based on self discovery.

This session aims to help participants identify or find positive traits about themselves as a leader, work out what kind of things they would like to develop and capture their goals with the aim to identify what support and skills may be needed to achieve those goals.

Three more weekly workshops will follow including planning for the future, communication and teamwork, and advocacy, access and inclusion.

Guest speakers for the event include, Brady Wilson, Tessa Deak, Shelley Irwin and Jed Altschwager.

Registering for the event can be done online via Eventbrite or contact the Wattle Range Council for more information.

## NEWS



Welcoming committee: Millicent Bowling Club members Steve Carnellor, Neil Whelan and Rod Gibbs.

## Photo call

Photographers are encouraged to submit their images taken within the Wattle Range Council (WRC) area in the last two years for the 2022 WRC Photographic Competition.

This year's competition will take on a similar format to the 2021 virtual exhibition with entrants submitting their selected photos in digital format only.

Organisers will hang seven entries per category in the gallery with all other submissions displayed on two screens inside the gallery throughout the exhibition.

The competition began in 2007 and has continued to develop, regularly exhibiting over 400 photographic entries.

\$3,000 in prize money and 10 categories ensure it attracts a wide range of photographers and subjects photographed with images from the exhibition selected for use in WRC's promotional material.

Digital entries close on September 10 and the exhibition will open to the public on Sunday, September 18.

Further information is available via the WRC website, Millicent library and Gallery or council office on 8733 0900.

## Art invitation

2022 celebrates 30 years of the Millicent Gallery and the call has gone out for artists to enter this years Wattle Range Art Exhibition to help mark the occasion.

The exhibition is an annual event highlighting the diversity of Wattle Range and its people through the arts.

Wide-ranging subject matter and medium are features of the exhibition with artists from across the region submitting work for display.

Categories include painting, printmaking and drawing, textile art, mixed media and sculpture in any medium.

The exhibition includes awards for youth, first time entrant, mayoral award and the overall Wattle Range art prize.

Entries close on November 1 and the exhibition opening is planned for Friday, November 11.

# Cash for community

By Caroline Hammat

Community, sporting and recreation groups are now invited to apply for Wattle Range Council's (WRC) current round of grant funding.

The funding consists of Community Financial Assistance Grants up to \$2,000, Sport and Recreation Grants up to \$2,000 and Community Infrastructure Grants up to \$50,000.

Millicent Bowling Club were one of four clubs to receive an Infrastructure Grant in the last round, successfully applying for and receiving \$13,143 to underground their power supply with a last minute application.

Last year the club had received notification of a successful Federal Government grant from the Office for recreation, sport and racing for \$43,300 to build a new shelter between the A greens.

Finding out after the paperwork had been filed and approved that the work could not begin until the power line that ran above the existing shelters was removed.

"The people who were going to put it up weren't allowed to work under the lines, plus if the lines break or something then you're in trouble." Steve Carnellor Vice President of the club said.

Club secretary Sarah Ross said "It was perfect timing, when we found out we that we had to do it we only had a week to put the grant application in.

"We weren't thinking of applying for it until this came up.

"If we knew beforehand that the lines had to be shifted we would've factored that into our original grant, but we didn't and it was the Wattle Range grant to the rescue."

The Federal grant assisted in funding the installation of the new shelter and extensive paving and the WRC Infrastructure Grant covered the cost of removing the stobie pole, putting the power underground and upgrading and moving the existing power box.

Both grants required a 50 percent contribution from the club.

Ms Ross spoke highly of the assistance received from council during the process "There is someone at the council who can help, we took all our stuff in with us and they told us what we needed."

Four WRC groups received Infrastructure Grants in the last round totalling \$123,143.



New shade: Vice president of the Millicent Bowling Club Steve Carnellor with greens director Rod Gibbs and greens committeeman Neil Whelan stand in front of their new shelter which is now above the underground power supply.

Other recipients were the Millicent and District Basketball Association \$40,000 toward the construction of a viewing clubroom, Mount Burr United Football Club \$50,000 to assist in erecting four new light towers, Lions Club Millicent \$20,000 for extension and up-

grade their facilities.

Applications for the current grand funding round must be received at Council by no later than Monday 5pm, August 15.

For further information contact WRC on (08) 8733 0900.



# 106 years young

By Caroline Hammat

Boneham Aged Care Services (BACS) resident Dardanella Williams recently celebrated her 106th birthday with a birthday cake and lunch at the site's La Fromelles cafe surrounded by close family.

Better known as Dell, she was born and raised on a farm at Lillimur in Victoria to Florence (nee Powell) and William Williams on August 2, 1916 the eldest of four siblings, Elva, Ruby and Allen.

Her birth was during World War 1 and this influenced the name choice with Florence's brother, Jack Powell, serving during the Dardanelles Campaign in Turkey.

Mary Altschwager has fond memories of her aunt and spending school holidays with the Williams family.

"She was great when we were kids because mum had the hair salon in Millicent so in school holidays my brother and I were packed off to Bordertown to either stay with grandma or grandpa or with Auntie Dell.

"Auntie Dell having seven children was great for us, and on a farm, we had a lovely time."

Mrs Williams and her husband Harry had five boys and two girls, and farmed at Bordertown for many years eventually retiring to Kingston.

Her son Bruce Williams said "They spent a lot of time at Hervey Bay with the caravan travelling around and then moved to Mount Gambier.

"Dad was feeling a bit crook at times and that's one of the reasons he bought mum to Millicent because she had two sisters here, Ruby Rogers and Elva England, they've since passed away."

Harry Williams died in 2002 and Mrs Williams remained living in her own home for the next 16 years until she was 102, reluctantly taking up residence at BACS and selling her home.

It was a difficult decision with Ms Altschwa-



Birthday Dell: Dardanella 'Dell' Williams with her family Marj Williams (daughter-in-law), Mary Altschwager (niece), Anne Wicks (daughter), Bruce Williams (son), Ian Williams (son), Elma Pilgrim (daughter) and Kevin Pilgrim (son-in-law) on her 106th birthday.

ger saying "Della had been such an independent woman for so long.

"She lived in the same street as my mum, Ruby, and would walk half the length of Fifth Street to play cards together.

"Occasionally they would get into arguments about the rules of the game but they were always great friends, really close.

"They moved to Millicent so that Dell had her sisters close by if anything happened, and as it turned out it did, and they were all there for each other."

The family all commented on her skills as a crafter and a cook and daughter Anne Wicks said "She loved all sorts of crafts, her crocheting was just beautiful."

These days Mrs Williams hearing and eyesight are failing and her mobility is slowing her down, until as recently as last year she was still helping to cook scones at BACS.

Four of Mrs Williams children travelled to be with her on the day, coming from Geelong, Bordertown, Murray Bridge and Mount Gambier with one son in Perth, who phones every Sunday, unable to make the trip.

Sadly two of Mrs Williams sons have predeceased her.

The siblings rarely get the opportunity to get together with Ms Wicks saying "She had a lovely time, and we are lucky she is in such a wonderful facility."

## Landing zone: Start on jetty renovations

By Elsie Adamo

After months of delays, works on the Southend Jetty have commenced, with Beachport soon to follow.

Organised by the Department of Infrastructure and Transport (DIT), the works will help maintain the two jetties relied upon by local fishermen to complete their work.

The works commenced last week and will repair the four lower landings by September. Other maintenance on the structure is expected to be completed in early 2023.

Works on the Beachport Jetty are expected to begin in September, which will refurbish timber piles framework, decking and rails on the structure, as well as install new safety ladders, replace decking, and repair landings, handrails and fenders.

While the works on Southend Jetty landings will be completed ahead of the crayfish-

ing season, Beachport fishermen will not be so lucky, with works on their jetty expected to last around a year.

When the project is underway, the end section of the Jetty will be closed to the public, with the shore end closed intermittently. Jetty fuel supply is expected to be impacted, but DIT has stated prior notice will be provided.

"The Department for Infrastructure and Transport is working closely with the local commercial fishing industry to ensure there are no adverse impacts to their fishing operations while this important work is undertaken," a DIT spokesperson said.

According to DIT the delays were caused by a lengthy procurement phase and difficulty supply of some materials. The Department did not respond to questions on why the Beachport project would take longer than initially planned.

An action point on the installation of fur-

ther Norfolk Island Pine along Beachport's Railway Tce was taken out of the plan at the meeting. According to the State Government, the contract for the work was given to Maritime Constructions, with 25 full-time equivalent contractors needed to complete the projects.

Infrastructure Minister Tom Koutsantonis said the renovations would ensure the future safety of the facilities.

"Beachport Jetty is one of the longest and most picturesque jetties in South Australia, it is a state heritage asset and is a popular fishing and recreational hot spot, both for locals and for visitors to the region," Mr Koutsantonis said.

"As well as being used for recreational purposes, Southend Jetty is one of the busiest commercial jetties during the fishing season, and the local commercial fishing industry relies on its six lower landings for its operations."

## Land plan

From page 1

- Consider rezoning the part of the Strategic Employment Zone to the south of the Southern Ports Highway (Rendelsham Road) for a zone which is more reflective of its mixed-use nature.
- Support the development of a non-government secondary school campus.
- Allow smaller allotments in the existing Rural Living Zone, without expanding the spatial extent of this zone and allow for the future expansion of the Rural Neighbourhood Zone into the adjacent Rural Living Zone.
- Seek to amend the Planning and Design Code to rezone the Employment Zone on Lossie Road for residential purposes.
- Consider streetscape upgrades and a township entrance statement along the Princes Highway on the eastern fringe of Millicent, as well as seeking to amend the Planning and Design Code to rezone the existing Employment Zone to reflect its mixed-use nature.
- Seek to amend the Planning and Design Code to rezone the area of Rural Zone between Willow Bank Road, the railway line and the Princes Highway for township-sized residential development.
- Seek to amend the Planning and Design Code to rezone the cemetery and quarry with an appropriate zone to reflect their use.
- Support the development of a variety of infill sites across Millicent.

The report highlighted that Millicent's population is not expected to grow substantially over the next 25 years, but new areas for land still needed to be considered. "It is unlikely that there will be strong demand for expanded commercial or retail development in the town centre, with some potential excess land," the report stated.

"Millicent's population increased by only one person between the 2016 and 2021 Censuses, to a population of 5,110 in 2021, Millicent had 78 net additional dwellings over the same period.

"This illustrates the way that new land supply is needed, even in situations where the population is stable."

Key priorities for Penola included additional zoning of residential and industrial land, and supporting the implementation of aged care facilities or developments.

Within Beachport, 13 actions were identified which would help combat future erosion and help ease land pressures within the township by allowing three-story builds and expanding commercial and light industrial activities to the nearby Muggleton. The plan was finalised in July by consultancy firm Holmes Dyer. The consultation report stated that feedback on the Millicent section was "generally supportive" with minimal changes made from the initial plan.

Any actions from the plan that review code amendments will still need to go through a targeted community consultation process.

## Grand Hotel Millicent

Bottleshop open for large range of products  
Try one of the great selection of local Coonawarra wines

**Open 7 days lunch and dinner**

Great new chef's menu including old favourites  
and vegan and GF options



55 George Street, Millicent SA 5280

08 8733 2242

thegrandhotel55@gmail.com



# Mary MacKillop feast day

By Kathy Fennell

Last Monday was the celebration of Mary MacKillop Feast day at Penola.

It was a day to celebrate Australia's first and only Saint.

A whole school mass was held in St Joseph's Catholic Church with other visitors also attending including students from schools in Western Victoria.

After Mass, students returned to classrooms and continued learning about Mary and participated in a series of activities for the remainder of the day.

"It is a very special day and people come from everywhere to visit the centre at Penola," Catholic parishioner Claire Larkin said.

Mary was born in Fitzroy in Melbourne in 1842 and in 1860 at the age of 18 moved to Penola.

It was in Penola where she met Father Julian Tenison Woods, a priest and scientist, and set up her first school, holding lessons in a small cottage.

In 1866 she set up her first dedicated school in a stable.

This site is remembered today as the Mary MacKillop Stable School park and is located on Queen Street.

In 1867 the classes moved to a purpose-built school now referred to as the Woods-MacKillop schoolhouse, located on the corner of Petticoat Lane.

While in Penola she also started up the Sisters of St Joseph's with the help of Father Woods.

Within weeks of the schoolhouse opening, Mary boarded the steamship SS Penola for the journey to Adelaide where she went on to establish the Cathedral school hall, officially took vows and became Mary of the Cross.

Within five years of taking her vows she



Claire Larkin celebrated Mary MacKillop feast day on Monday.

had established more than 30 schools in South Australia. of the plight and needy and worked with families who lived in isolated areas of Australia.

She was very conscious of the plight of the poor and the needy and worked with families who lived in isolated areas of Australia.

As a result she pioneered a new form of re-

ligious life in Australia and started a system of Josephite schools that would provide education, especially for the children of the poor.

Mary was declared a saint in October, 2010.



MARY MACKILLOP  
PENOLA



## PROSPECTIVE PARENTS INFORMATION EVENING

Wednesday | 5.30pm  
24th August



An evening for all families in Penola and surrounding area considering MMMS

Please call 8737 2902 to RSVP by August 19th

MARY MACKILLOP MEMORIAL SCHOOL INVITES YOU TO

## COME AND TRY PLAYGROUP

COME AND ENJOY TIME TO PLAY AND EXPLORE WITH YOUR CHILD GUIDED BY OUR EARLY YEARS COORDINATOR.

**MON AUGUST 22ND**  
9.30 - 11.00AM

**BRING A PIECE OF FRUIT FOR A HEALTHY SNACK**

Call 8737 2902 or email [jcoote@mmms.catholic.edu.au](mailto:jcoote@mmms.catholic.edu.au) by August 19th to book a spot

### MARY MACKILLOP MEMORIAL SCHOOL INVITES YOU TO

## COME AND TRY OCCASIONAL CARE

An early years service for families of 3 - 5 year olds.

**FRIDAY 26TH AUGUST 8.45am TO TUESDAY 23RD AUGUST 11.45am**

CONTACT THE SCHOOL BY 16TH AUG TO BOOK A PLACE FOR YOUR CHILD  
Phone 8737 2902 to book [jcoote@mmms.catholic.edu.au](mailto:jcoote@mmms.catholic.edu.au)  
RSVP by August 19th

Helping Children Discover Fun in Learning

MARY MACKILLOP PENOLA 





Turtle country: Ebony Gardin paints native animals on to one of the six totems.



Animal totem: Chloe Gysbers, concentrates on completing the kangaroo painting.

# Totems for connections

By Caroline Hammat

The idea to create more connections with Millicent High School (MHS) students to areas around the school has led to the latest arts project being undertaken.

Six redgum totem poles are currently being painted by students Demi Bevan, Deni Brown, Chloe Gysbers and Ebony Gardin with guidance and assistance from MHS Aboriginal Education Officer Jenny Bishop.

With themes representing the Aboriginal, Torres Strait Islander and Australian flags, local animals, respect and meeting places the totems will be placed in front of the school facing Mount Burr Road.

The site will be landscaped and paved and include the installation of a newly painted picnic table to complement the totems and create a space to meet.

Ms Bishop said "We've got four girls that are helping to do these totem poles.

"I picked who I knew was going to do a good job and what these young girls are doing is beautiful, they are such good little artists.

"I wanted non-aboriginal kids to be involved in this as well as its about them to, it's not just about my little mob.

"They get right into it, they love it."

MHS principal Todd Watson said "For a long time we have had the garden (Indigenous meeting place) that a lot of time and effort has gone in to, and that is a great meeting place for special occasions and some of the projects we do but it is a little bit out of the way.

"Here is an opportunity to have something that is pride of place in front of the school to recognise the connections that our school does have.

"And it doesn't need to just be Indigenous students, if we want coming together we want everyone to have a part in it, and the kids are really on board.

"Any opportunity we get to have our kids



Flag pride: Aboriginal education officer Jenny Bishop with students Ebony Gardin and Chloe Gysbers.

have a connection to school and connection to country I think it is fantastic."

Ms Bishop added "That is why I like doing meeting places because when you all come together you come together as one"

"I think they are going to look beautiful, it is a privilege to do it and having something here of my art and the kids art, I think its great."

The six large redgum timber poles were

donated and delivered to the school by Wayne Batchelor who sourced them from his farm at Wrattobully, also donating four more for the Millicent North Kindergarten garden.

Ms Bishop said "We've already done the North kindy ones, but they need to go by council to make sure they that they are not (installed) too close to the fence.

"Neil Reilly (Millicent Community Learn-

ing Centre instructor) is going to do that and he's the one that's going to put these in for us when these ones here are all done."

The site planned for the six totems is currently home to the pharaoh sculpture carved by students in 1969 and the more recent pyramid carved by Ivo Tadic over 20 years ago.

Both existing sculptures will be relocated to other areas of the school.

## Small Halls Festival comes to Robe

Robe residents are in for a treat, with the Festival of Small Halls scheduled to visit next month.

Multi-instrumentalist duo Mal Webb and Kylie Morrigan, along with songsmith Chris Tamwoy, will be heading off on tour for the Festival of Small Halls Winter Tour 2022: South Australia. While previous tours have tucked in a handful of shows through the east of The Festival State, before continuing east to Victoria, this will be the first Festival of Small Halls tour to visit the small towns and villages of South Australia exclusively.

Celebrating the tenth year as a touring festival, the Winter Tour 2022: South Australia will visit fourteen communities, from Robe to Marion Bay, and up through the Flinders Rangers along The Outback Highway to Beltana.

Producer Eleanor Rigden said the team is



On tour: Mal Webb and Kylie Morrigan will be performing in Robe as part of the Small Halls Festival. Picture: SUPPLIED

"nothing short of thrilled" to be embarking on the first all-South Australian Festival of Small Halls Tour.

"To be welcomed into such a variety of beautiful towns and villages is exciting enough, but to be doing it with artists of the

quality of Chris Tamwoy and Mal Webb and Kylie Morrigan feels too good to be true," she said.

"The incredible nature of Festival of Small Halls shows to leverage the quality of brilliant music to bring communities together and showcase of the best they have to offer is one of the best things about this magical tour."

Mal Webb and Kylie Morrigan are established touring musicians, and they're itching to get back on the road. Co-billed with Mal and Kylie is Chris Tamwoy, a Torres Strait Islander musician and songwriter, who has performed with Birds of Tokyo and Colin Hay, as well as reaching the Grand Finals in Australia's Got Talent in 2016.

The show will be at Mil Lel on Saturday, September 10 and Robe on Sunday, September 11.

Tickets on sale from July 13 at [www.festivalofsmallhalls.com](http://www.festivalofsmallhalls.com)

Beautiful inspiration range, inspired in Adelaide, made in Australia, available in Penola at Di's...



Di's Gift 'n' Flowers

43 Church Street, Penola 5277  
08-8737 2284

[disgiftsflowers@gmail.com](mailto:disgiftsflowers@gmail.com)  
Open: Mon-Sat: 9am to 5pm Sun: 10:30am to 5pm



# Hotel in the march of time

**By National Trust of SA Penola Branch**

In association with State Heritage, Penola's branch of National Trust SA has developed a mobile phone app called Penola Walk With History to enable people to learn more about historic sites within Penola on self guided tours. The following is one of the subjects from this app.

**PRINCE OF WALES HOTEL**

In the early years of Penola, Alexander Cameron's Royal Oak was the only licensed hotel in the town.

In 1860 its former licensee, John Bowden, built his own hotel, the Prince of Wales.

His son-in-law, AJ Edwards, who married feisty horsewoman Catherine Jane Bowden, owned the hotel in 1862 and sold it to John Reilly in 1882.

Members of the Reilly family managed the hotel and in 1949 changed the name to Reilly's Hotel.

When Charles Reilly died in 1951 the busi-



The Prince of Wales Hotel in Penola when it was named Reilly's.

ness was leased.

A galvanised iron building at the rear acted as sample rooms.

Merchants from Adelaide and Melbourne would visit the town regularly to display and sell their goods from these rooms.

Advertisements in the Border Watch in 1882 offered "Every Accommodation for Commercial Gentlemen and South-Eastern Line of Royal Mail Coaches call daily".

The Basheer family from the Kalangadoo Hotel purchased the hotel from Messrs JK & LJ Reilly, Mrs H Hubber and Dr John Rollison in December 1963 and took over the management in 1964.

In 1965 they demolished the old building and built the present one, renaming it the Log Cabin Hotel-Motel.

This was opened by Mr F Walsh, Premier of South Australia on July 11, 1966.

Soon after the change of ownership, and before the demolition of the old building, there was great interest one Saturday afternoon following Penola Football A Grade team winning the premiership when three local identities, Bray Kidman, Andy Anderson and Graeme Robertson each rode an elephant from Bullen's Circus down Church Street.

The elephant handler, who had been in the pub for some time, took a bet that he could have his elephant reach through the front door of the pub and take a glass of beer from the bar.

He almost succeeded, but lost the bet.

The elephant was quickly removed when it was discovered that the cellar was immediately beneath him.

Mr Fred Basheer, one of the new owners, was reported as having a conniption before the elephant was moved. A conniption is described as a feeling of panic or hysteria.

There have been many different owners since and in recent years the name of the pub was quite rightly changed back to the original Prince of Wales.

## CALENDAR OF EVENTS

COMPILED WITH THE ASSISTANCE OF WATTLE RANGE COUNCIL

**13 August**

- Paint a handsome hare, Parker Estate
- Empowering Able Young Leaders

**18 August**

- Penola Coonawarra Arts Festival Annual General Meeting

**20 August**

- Empowering Able Young Leaders

**25 August**

- Monthly Movie @ Beachport Cinema

**27 August**

- Empowering Able Young Leaders

**2 September**

- Empowering Able Young Leaders

**4 September**

- Father's Day Walk, Millicent Domain

**16 September**

- Millicent Craft Group Quiz Night

**25 September**

- Community mulch day, Penola

**14-17 October**

- Geltwood Festival including Market Day on Oct 16

**23-25 September**

- Pines Enduro Off-road race

**25 September**

- Glencoe Central Primary School 50th Birthday

**1 October**

- Official opening of Seniors Month

**2 October**

- Beachport Market Day

**2-4 October**

- Millicent Orchid Society Spring Show

**29 October**

- Robe Beer Festival, Robe

**29-30 October**

- Penola PA&H Society Show

**4-6 November**

- Millicent AH&P Show

**5 November**

- Coonawarra Running Festival

**11 November**

- Womens Wellness Clinics, Penola
- Wattle Range Art exhibition opening

**REGULAR EVENTS**

**Every Monday**

- Senior Citizens, Millicent RSL
- Yoga at Beachport
- Ukulele classes at Penola RSL
- National Karate Academies, Penola Primary School Hall
- Millicent Choral Society practice, High School music room
- Penola Lions Bus to Mount Gambier
- Leggo's Boxing Training, Penola Basketball Stadium

**Every Tuesday**

- Red Cross Community Shuttle from Millicent to Mount Gambier
- Yoga at Millicent, Community Learning Centre
- Dance to Keep Fit, Beachport
- Millicent Men's Shed
- Melody's Performing Arts classes, Rymill Hall, Penola

- South East Junction Activities

**Every Wednesday**

- St Mary's Op Shop, Penola
- Millicent Art & Craft Group, Pottery
- Penola Men's Shed
- Social Bowls, Penola
- Ladies only Burlesque classes, Nangwarry
- Social tennis, Penola
- Fun exercise classes, Millicent Uniting Church
- Leggo's Boxing Training, Penola Basketball Stadium
- South East Junction Activities
- Cards at Beachport Cinema

**Every Thursday**

- St Mary's Op Shop, Penola
- Seniors Online, Millicent Library
- Craft at Beachport Cinema
- Millicent Men's Shed
- Ladies only Burlesque classes, Nangwarry
- Red Cross shuttle from Millicent to Mount Gambier
- Beachport Ukulele Group
- Indoor Social Bowls, Millicent Uniting Church
- Family connections program, Penola
- Craft at Beachport Cinema

**Every Friday**

- St Mary's Op-Shop, Penola
- Seniors Online, Millicent Library
- Penola Bowls women's competition
- Millicent RSL Open
- Fun exercise classes, Millicent Uniting Church
- Dance classes, Penola
- Bar open Coonawarra Community Club

**Every Saturday**

- Kalangadoo Farmers Market

- St Mary's Op Shop, Penola
- Millicent Art & Craft Group
- Penola Bowls Club men's competition
- Penola Croquet Club
- Aqua aerobics, Penola pool

**Every Sunday**

- Beachport Ladies Golf Day
- Millicent Men's Shed

**First and third Thursday of the month**

- Book Club, Millicent Library

**2nd & 4th Thursday of the month**

- Scribblers Writing workshop, Millicent Library

**2nd & 4th Friday of the month**

- Lego Club, Millicent Library

**3rd Tuesday of the month**

- Millicent Local History, Library
- Penola Probus Club

**Last Friday of the month**

- Coonawarra Hall tea night

**3rd Sunday of the month**

- Beachport Hotel family fun day and jam session

**4th Thursday of the month**

- South East Family History Group meeting

**4th Friday of the month**

- Beachport Film Society showing

**Last Monday of the month**

- Penola Leo Club

**Last Tuesday of the month**

- Millicent Cancer Support Group meeting

# Connect your business with the community

**Advertising**

08 8741 8170 | advertising@tbwtoday.com.au

**Classified**

1300 666 808 | www.borderwatch.com.au

**TBW Today**

TBW Today Pty Ltd  
ACN 644 311 937



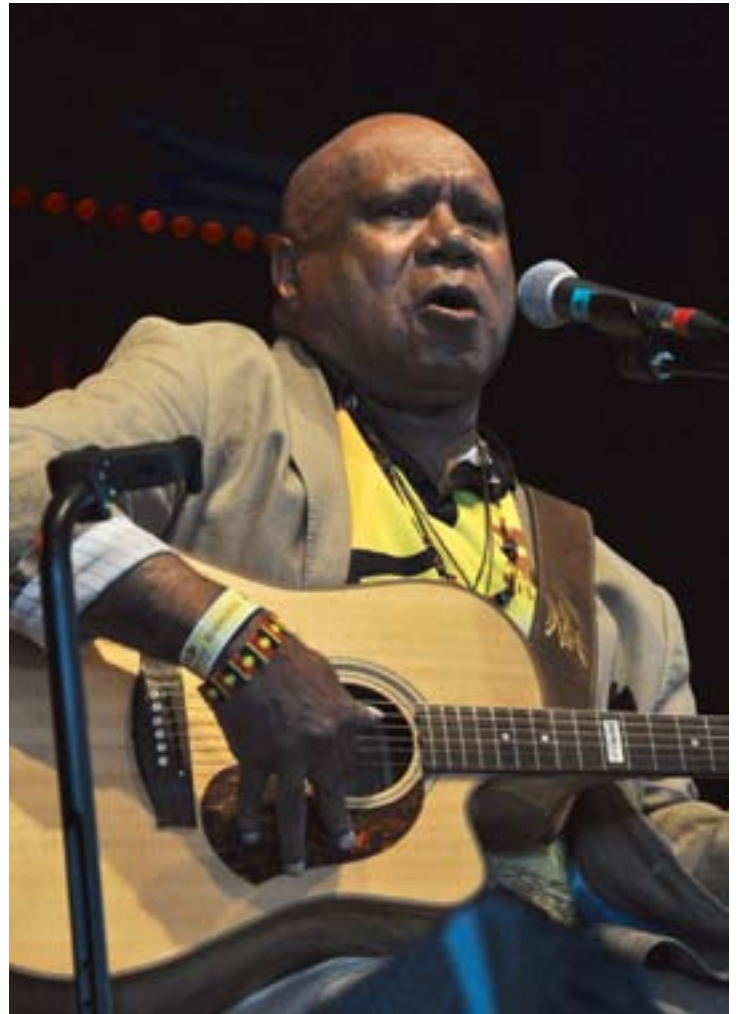

The late Archie Roach at Bellwether Wines at Coonawarra.

Pictures: SUPPLIED Locals have fond memories of Archie Roach performing at Coonawarra.

# Memories of Archie

The late Archie Roach certainly left his impression and fond memories at Bellwether Wines at Coonawarra.

Roach, an extremely talented musician, vocalist and story teller passed away recently after a long illness.

Sue Bell from Bellwether Wines said she was extremely sad when she awoke to the news that Archie had passed.

“Archie was a true survivor, yet died too young after an incredibly tough life.

“He was the ultimate optimist even though he was a member of the stolen generation,” Sue said.

Roach survived homelessness, alcoholism, a stroke, lung cancer and losing the love of his life, Ruby Hunter.

Throughout life’s challenges Roach always said it was love and music that always saved him and brought him back.

“One of my favourite memories at Bellwether was when Archie came to Coonawarra as our guest for the 2016 Penola

Coonawarra Arts festival.

“The show was supported by Nancy Bates and Kelly Menhennett.

“An evening of stories and song with only 75 people, all mesmerised by Archie’s warmth and ability to tell stories of harsh truth, yet make you smile, laugh and cry in as many moments,” Sue said.

Roach survived much hardship but he always got back up and looked for the positives in life and spread alot of love.

He educated the world about Australia’s dark history of the stolen generation with his music.

He was able to make people listen and try to understand the hurt it caused.

“I am so sorry Archie’s life was unfair in many unnecessary ways, and to his family at this time.

“It is a great loss to Australia.

“His music and the lessons within will continue to teach future generations.”



The late Archie Roach performing at Bellwether Wines at Coonawarra.

# Looking for a new view?

Access the Property ReView for a detailed report into your potential new home.

Your trusted source of property



# Pharaoh is on the move

By Caroline Hammat

Millicent High School's (MHS) 7 foot tall limestone pharaoh statue has stood as a silent sentinel on school grounds since 1969 and after approximately 20 years at its current site, a grassed island at the front of the building, it will soon be re-located.

The pharaoh and nearby limestone pyramid will be moved to make room for a new Indigenous statement sculpture currently being painted by students and Jenny Bishop the MHS Aboriginal Education Officer.

MHS principal Todd Watson said "I still want to keep them because to me they are a part of the history of the school.

"Some people question why it is front of our school, it is still part of our school history that students have been involved in."

The plan is to relocate the pharaoh to the Western entrance in the corner of the the existing playground which is very close to the site on which it was originally carved.

To unravel some of the mystery that surrounds the why of the pharaoh the South Eastern Times spoke to Ian Were the MHS art teacher behind the project at the time.

"I was appointed (to MHS) in 1966 and stayed for four years, 1969 was my last year, I was young and enthusiastic and not that much older than some of the students who were 16/17.

"I was greatly taken with the limestone quarries when I visited, they always reminded me of an archaeological site.

"My memory isn't clear but I believe each student was given a small block of limestone and we did some smaller carvings at one stage to work out what might be appropriate and what you can carve, limestone is soft and can easily break the forms can't be overly complicated.

"It was this particular fourth year class of boys and I thought it would be a great project for them, everyone designed something and



Millicent High School's Aboriginal education officer Jenny Bishop and school principal Todd Watson with the iconic pharaoh.

one of the students did a small pharaoh.

"There were lots of possibilities and we could've done a simple abstract shape but we decided that we liked the idea of a person.

"The pharaoh was good because the hands weren't hanging out and there weren't bits that could be easily broken, the shape of the throne meant there was less carving.

"When the block was delivered I think it

was 3 cubic metres or something like that, it was a hefty block.

"I was keen to do different things and we did whatever we could that involved the students outside the classroom.

"One of the projects was in the admin building, there was the tall atrium with windows around the top, we got a very tall ladder and measured the windows and did some contemporary stained glass windows using

cellophane and cardboard, that was a fun project to do."

Mr Were was appointed to Mount Gambier Technical High School after his four years at MHS and spent a total of seven years in the South East "It was a really interesting time to be there at a relatively young age and many of us were involved in things like the Company of 7.

"We started painting backdrops for their various productions and other staff members were in those productions."

Although Mr Were said he enjoyed teaching in the country he did not find the city placements as fulfilling and left teaching to make his own artwork for a number of years eventually moving into arts writing and editing in the mid 90's.

Now living in Brisbane for almost 20 years his links to Millicent don't stop with the pharaoh as he currently writes for a local online newspaper the Westender edited by ex-Millicent resident Jan Bowman.

"I met her accidentally in the West End in Brisbane and she said she came from Millicent and we worked out the year I left the school she started as a student."

Mr Were has been back to view the sculpture from the roadside in recent years and in a 1969 edition of the South Eastern Times that recorded the carving he was quoted as saying "If it looks any good when it's finished, it'll stay."

The five fourth year students that worked on the seven foot high statue were Graeme Manhood, Dale Zadow, Stuart Iain, Ronald Thomas and Peter Moorfoot.

The nearby pyramid was carved by Ivo Tadic around the year 2000 and the pharaoh was painted a few years later in 2006.

Hannah Wilson was a year eight student at the time and confirmed she was involved in the painting "It was done as part of a community project to beautify the school, my group decided it would be a good idea to paint it.

"We didn't do any research into the back story of how it got there at all."

## Abuzz with activities at Mary MacKillop school

It has been a hive of activity at the Mary MacKillop school in Penola since the start of term three.

Last Friday saw students from all classes participate in a 'card and casual' day where students came to school dressed in casual clothes and bought with them a can of food.

A total of 141 tins of food were collected which will be donated to the Vinnies Winter Appeal.

The tins varied in food and included soup, spaghetti, noodles, vegetables and much more.

This day is held annually at the school.

At the start of the term two new students, Elsie and Pearl, were welcomed into the reception and year one class along with new staff member Cobie Walters who will be



Harry, Henna, Levi, Charlie, Elijah and Tess having fun in the playground on casual and can day.

working with Alison Smith in the year four/five class.

Science has also been a popular topic with the reception/year one students ex-

ploring earth and space.

Students have investigated daily and seasonal weather and observed the related effect on the sky and landscape.

Students made wind chimes, conducted investigations of hot and cold temperatures and wind strength and created their own weather symbols.

Year two to five students ventured into outer space exploring how the rotation of the earth results in day and night, and they investigated the solar system.

The year six class has been exploring volcanoes and their formation including an investigation of lava viscosity.

The year four/five class enjoyed making French-themed food.

The menu included cheesy toast, salad

with french dressing, french onion soup and dip, petite frittatas and French palmier cookies with homemade puff pastry.

There will be an open morning at the school on Wednesday, August 24 for parents and families to come along and see what learning looks like at Mary MacKillop.

On the same day in the evening there will be a parents prospective evening at 5.30pm for anyone who is interested in joining the school.

Come and try playgroup sessions are held each Monday from 9.30am to 11am and occasional care sessions for three to five year olds will be held on Tuesday, August 23 and Friday, August 26 from 8.45am to 11.45am.

Bookings can be made at the school.

**NEW BLUEY and BINGO**  
sports balls that float

**AUSSIE TOYS ONLINE**



# New members needed

By Elsie Adamo

The Millicent Royal Flying Doctor Service (RFDS) group has made a call for new volunteers to help out its longstanding members who are becoming less mobile.

At the group's annual general meeting (AGM) last week, the executive made it clear they were on the lookout for more volunteers to help carry on the group's proud tradition.

A majority of the group's members are over the age of 80, which has made some of its fundraising activities difficult.

The local group has been raising funds for the RFDS for 25 years, raising almost half a million dollars for the charity.

Max Blacketer serves as the group's secretary and hopes to find some locals who would like to join.

"We are all old, we only have around five people under 80," Mr Blacketer said.

"We need some more younger people to give us a hand, although everyone is welcome no matter their age."

Mr Blacketer says that at 84, he is not nearly their oldest member.

"I think she is 89, and she has been helping out for a long time," he said.

A lot of the money raised by the group is collected from stalls in front of supermarkets and shops, but with aging volunteers, Mr Blacketer said it becomes tricky.

"Two of the 87-year-old women want to sit out in the street in the cold...but I just do not want to let them."

The club is about to trial moving their regular meetings to later in the day, 5.30pm, to capture some extra volunteers who may not have been able to make it due to work previously.

"That way, hopefully, it will make it easier to come to the meetings," Mr Blacketer said.

RFDS Volunteer Fundraising Specialist Lindy Allchurch said the local group had a lot to be proud of.



Millicent RFDS Fundraising group President Ken Hanes with volunteers at the recent AGM.

"They [Millicent] are one of the oldest groups in the state," Ms Allchurch said.

"What they have managed to achieve in that time is fantastic."

"The money they [the volunteer groups] raise goes towards purchasing our planes."

Ms Allchurch said the local group is typi-

cal of others around the state, but some fresh helping hands would be welcome.

"Most of my volunteers are past retirement age which is fine," Ms Allchurch said.

"That is when you have time to be able to volunteer. But we certainly do need volunteers here in Millicent."

"If anybody wants to join the group, they will be warmly welcomed."

Mr Blacketer said if any community members were interested in joining, to reach out to him directly or to attend the groups next meeting on the first Tuesday 4 October at 5.30pm at the Millicent Uniting Church Hall.

## All welcome at the arts festival AGM

By Kathy Fennell

The annual meeting of the Penola-Coonawarra Arts Festival is to be held on Thursday, August 18, at 5.30pm, at the Penola Visitor Information Centre.

Plans have started for the four-day event to be held from May 18 to 21, 2023 which celebrates the rich literary history, live music, performing arts, film, children's activities, fine food and wine. Festival committee chairman John Mossop encourages all to attend the annual meeting.

"We need more committee members and volunteers to come on board so this event can continue on to make it the success it is."

"It is a big job putting the festival together and the more people we can get to help the lighter the workload," John said.

This year's festival was a great success and attracted many people from away but was also supported by locals.

"It was such a shame that the weather turned nasty on the Sunday for the kids activities and this is something we will look at for next year," John said.

The workshops that were held throughout the festival were very well supported and it is planned to run these in 2023.

The committee will be searching for financial assistance in the way of grants to help run the festival. The John Shaw Neilson Art competition will once again be held and with a \$12,000 first prize there will be many artists starting to prepare their entries.

This year, most of the major awards went to locals with Dagny Strand taking out the major prize.

Evolving since 1991, it will be the 31st running of the festival in 2023. In 2013 the festival won a South Australian Regional award from Brand South Australia. This award highlights individuals or organisations that have made significant contribution to their region and the state over a 12 month period.

The festival has grown to be one of South



Penola-Coonawarra Festival committee chairman John Mossop.

Australia's leading arts festivals and won the UNSECO (Adelaide Chapter) award in 2015.

The award was for an outstanding contri-

bution to the regional cultural life of South Australia, promoting all facets of the Arts, and cultural tourism.

## Roadworks are nearing completion

Line marking along the Southern Ports Highway near Millicent should soon be completed, according to the Department of Infrastructure (DIT).

The works which started in May have been long delayed, initially set to be finished in early June before being pushed delayed multiple times.

A DIT spokesperson said the line marking should be completed by the end of this week, barring any further delays to weather.

As soon as the line marking is completed, speed limits along the section of the highway should return to normal.

The spokesperson said any remaining patching and resurfacing works along the Southern Ports Highway would resume when the weather improves and ground temperatures increase which is expected from September 2022.

Other highways within the region have also been subject to line marking delays, which the department claimed were due to weather and a shortage of available line marking contractors.







Casey and Damien Ditroia and Rob Samuel-White enjoying the 70th birthday party.



Rory Mooney and Fran Raidis at the 70th birthday celebrations.

# Celebrating 70 years

By Kathy Fennell

Local Peter McDonald celebrated his 70th birthday with many friends and relatives at Raidis Estate on the weekend.



Carol McDonald celebrates a 70th birthday toast to husband, Peter.



The man of the moment Peter McDonald, second from left, with daughter Belinda O'Toole, son Jamie McDonald and wife Carol McDonald.



Simon White, Jane Pearce, Belinda O'Toole and Kate White enjoying the 70th celebrations.



Sharon and Graeme Venn enjoy the 70th birthday celebrations.



Greg and Kerry Marcus came from Adelaide for the 70th birthday celebrations.



Pud Auld and Tim Krieger from Kalangadoo enjoy the 70th birthday festivities.



Visiting from Adelaide for the 70th birthday celebrations Nenette Stopps and Tim O'Connor with local Deb Kuhl.





News editor Lis Champion with Eleanor Burrow at The Pennant relaunch.



Ocky Le Roux, Kat Searcy and Heidi Guyett.

# A new era for local news

By **Kathy Fennell**

The Penola Pennant re-launch celebration was held at Raidis Estate last week with many locals, businesses and The Pennant team attending.



Enjoying a drink at the Pennant relaunch, from left, Carly Moulton, Jo O'Connor and Tara Batt.



Tim Kidman and Luke Trotter at The Pennant relaunch.



Part of The Pennant/Border Watch team from left Aidan Curtis, Elsie Adamo and part owner Damian Morgan.



Diana Sims and Loretta Sims enjoying nibbles at The Pennant relaunch.



News editor Lis Champion with Emma Raidis at The Pennant relaunch.



Kathy Kelly, Mel Smith and Lyn Doyle enjoying The Pennant relaunch.



At the Pennant relaunch from left Brian Wagner, news editor Lis Champion, Mayor Des Noll and Benedetta Rusconi.





Melanie Gibson with racks of jumpers on display at Ducky's Surf.



Damon, Michelle and Dylan Randall of Roger Smith's Auto Repairs.

# Recognise great business

By Caroline Hammat

Local businesses are putting their best foot forward in preparation for the annual Outstanding Business Awards hosted by the Millicent Business Community Association (MBCA).

Community members are encouraged to nominate their favourite businesses and employees for the 2022 awards in one of eight different categories.

The categories include construction, service, retail, agriculture, hospitality and tourism, employee and young employee of the year.

Organisers have stressed the nominations are based on the quality of the nomination and not the quantity received and judging will be based on an updated criteria list in comparison to previous years.

Lee Morgan, chair of the MBCA, said "Once businesses are nominated they have to come back with a response and examples of how they achieved it."

Criteria includes examples of outstanding service provided, aspects of good business presentation and examples of sustainability and innovation.

Prize money will be awarded to young employee of the year with all other category winners receiving an award.

Nomination forms are available at the Millicent Newsagency and the Millicent Visitor Information Centre or online via [www.millicentbusiness.com](http://www.millicentbusiness.com) and close on the August 28, 2022.

All winners will be announced at the MBCA awards night held on October 8 at the Millicent Civic and Arts Centre.

The businesses photographed showcase a small selection of the many local businesses doing great work in Millicent and districts.



Andy's Bakery staff members Colleen Stewart, Tracey Watts and Melissa Dillon.



Grant Bowden and Angus Doecke keep things turning at Millicent Tyre Centre.



New owners of the Chook House on Mount Gambier Road are Andrew Girolamo and Gede Santosa.





Manager of Millicent Can and Bottle Depot, Kay Cook (centre), with staff members Peter Buchanan and Donna Cranwell.



Heaven on a Hanger business owner Lisa McCourt with new stock display.



Owners of In2 Trophies, Monogramming, Workwear Jo and Ian Seebohm.



Sean Sparkes, manager of Millicent Lakeside Takeaway, with customer Neil Widdison.



Vanessa Good and Henry Inglis are familiar faces to regulars at the Somerset Hotel.



Bill Davis has bikes galore at his Millicent Toy Kingdom store.



Karen Duncan, owner of Habit Patch in George Street.



# Motoring

## BMW iX3 looks the part

By Ewan Kennedy, Marque Motoring

BMW iX3 is the full electric version of German marque's mid-sized X3.

It has no internal combustion engine to provide extra range if its batteries run out of power.

It's sold in Australia with quite a few features that are frequently extra cost options; these include metallic paint and the M Sport package with 20-inch M aerodynamic wheels.

### STYLING

Very BMW. While other makers of electric vehicles like to go for a different perhaps futuristic look, the iX3 looks instantly like a Bimmer from any angle.

There are some blue highlights on the outer edges of the lower sections of the front and at each corner of the lower panel at the rear.

There are also blue colours on the BMW "radiator grille".

Obviously, it doesn't have a grille because there is no water being cooled there.

BMW and other EV makers do include a grille because buyers feel that a plain front end just looks wrong.

Mind you Elon Musk's Teslas don't have a grille either and are selling faster than the factory can produce them...

Also standard is a panoramic sunroof that covers most of the roof area.

### INTERIOR

The dashboard area is divided into three distinct areas. That in front of the driver has a 12.3-inch digital instrument cluster.

There's another 12.3-inch digital screen in the centre of the dash area.

It's wide, but rather too low which means the view ahead on the screen if our using it for navigation isn't as far ahead as we like.

On the other hand, the width of the screen means you can see a lot of the things that you are missing out to the side of your road.

Which may mean that you see things that you hadn't realised were there, and perhaps decide to visit if you're on a sightseeing trip.

Comfort and space in the front seats is good, with a wide range of electric adjustments. It has under-thigh cushion extenders, which I really enjoy as I have long legs and these add further ways of getting comfortable.

In their own way these cushion extenders probably add to the safety on long trips because drivers are safer if they aren't wriggling about to stay relaxed.

### INFOTAINMENT

Our iX3 had the BMW Connected Package Professional which has Apple CarPlay and Android Auto and a Harman/Kardon 16-speaker surround sound system.

There's wireless smartphone charging which saves having to wrestle with cables. Just put your phone in its spot and you're getting more juice into it.

### POWERTRAIN

eDrive is the new drive technology found in all BMW i models and plug-in hybrids, and is essentially comprised of an electric motor, high-voltage lithium-ion battery and an intelligent energy management system.

The integrated drive unit brings the electric motor, power electronics and transmission together within a single housing, and generates 210kW and 400Nm.

All eDrive-equipped vehicles rely on a special performance li-ion battery to store energy, and utilise a built-in cooling device to constantly keep the unit at the ideal operating temperature, helping increase output and maintain service life.

A five-year Chargefox subscription is included in the price of the BMW iX3 sold in Australia.

### SAFETY

The BMW X3 has a five-star ANCAP safety rating from for the xDrive20d and xDrive30i vari-



Fully electric: Though it's fully-electric, the iX3 looks like a Bimmer from any angle.

ants. However, the iX3 has not been tested at this stage.

Ways of avoiding a crash are strongly featured in this electric Bimmer.

It has automatic emergency with cross-roads warning, lane-keep assist, blind-spot monitoring, front and rear cross-traffic alert, evasion assistant, speed limit assist, as well as Steering + Lane Control Assistant (Level 2 autonomous mode).

### DRIVING

Performance! This is why we like driving all electric vehicles.

They have instant reaction to the accelerator pedal. BMW has always produced vehicles with a sporty feel in everything they do and that performance is just wonderful in any model they make.

This is going to sound childish but I like nothing more than to sit at a red traffic light beside a big car that's got a lumpy sounding V8. I look at him, and he looks at me in my black SUV and blips his throttle - ready to make me look silly when the green lights come on.

The lights change and that instant electric torque pushes me back in the seat, in about three seconds we are up to 80 km/h and I back off. The other driver comes alongside, checks out the tame looking Bimmer and shakes his head.

Then again, I've driven many V8s in my 50-year career as a motoring journalist and there's something about V8s that I really enjoy. If I had plenty of money to spare, I would buy a V8 for track days and just cruisin' around town and keep the somewhat boring EV for everyday use.

Handling of the BMW iX3 is pretty good, but there's a feeling of heaviness when you're taking corners at speed due to the fact that you're carting about half a tonne of batteries about.

There's good feel through the steering wheel and the seats support well so you don't shift about when driving hard and can concentrate on the road.

BMW says the iX3 can cover 460 kilometres on a full battery charge. During our testing on motorways, in the suburbs and on country



Picture: SUPPLIED

roads we covered 284km and computer advised its batteries had a further 180km before it was close to being fully discharged.

### SUMMING UP

A couple of times a year my wife and I go on long holiday trips from our home on the Gold Coast. Once we are a long way of out of town there's not many places to charge an electric vehicle. And when we do find a charger, we have to wait for several hours to get decent range out of the car.

When we can buy an EV for about the same price as a petrol or diesel SUV and charge it up less than an hour to give us a range of at least 500km, we will seriously think about one.

### RATINGS:

- Looks: 9/10
- Performance: 9/10
- Range: 8/10
- Safety: 8/10
- Practicality: 6/10
- Comfort: 8/10
- Tech: 9/10
- Value: 7/10
- AT A GLANCE
- MODEL RANGE

■ BMW iX3 RWD electric vehicle: \$114,900  
**Note:** This price does not include government or dealer delivery charges. Contact your local BMW dealer for drive-away prices.

### SPECIFICATIONS (BMW iX3 RWD electric vehicle)

#### POWERTRAIN:

- Maximum Power: 210 kW
- Maximum Torque: 400 Nm
- Range: 460 km
- Combined Fuel Cycle (ADR 81/02): zero
- CO2 Emissions: zero

#### DIMENSIONS, WEIGHT AND CAPACITIES:

- Length: 4734 mm
- Wheelbase: 2864 mm
- Width: 1891 mm
- Height: 1668 mm
- Turning Circle: 12.1 metres
- Kerb Mass: 2180 kg

#### BRAKES:

- Front: Ventilated disc
- Rear: Ventilated disc

#### STANDARD WARRANTY:

- Three years / unlimited kilometres
- Battery: Eight years / 160,000 kilometres



# WEATHER

## FORECAST

### Warnings

See [www.bom.gov.au/australia/warnings](http://www.bom.gov.au/australia/warnings)

### SOUTH AUSTRALIA:

#### State Forecast:

Mild with showers mostly clearing to the east during the early morning, then re-developing about western and southern districts during the day, more likely about coastal areas. Possible gusty storms about Lower Eyre Peninsula, Kangaroo Island and the Lower South East. Moderate to fresh north to northwesterly winds tending westerly in the west.

Friday. Showers across the agricultural area and the south and east of the Pastoral districts, with higher rainfall totals more likely in the south.

Possible storms south of about Port Lincoln to Renmark. Mild with moderate to fresh north to northwesterly winds, tending northwest to westerly in the west and far north.

Saturday. A high to very high chance of showers over the agricultural area, grading to a slight to medium chance over the far south of the pastoral districts and West Coast on Saturday, easing on Sunday and mainly contracting to the southern agricultural area by Monday. Cool in the south grading to mild to warm in the far west and far north. Moderate to fresh northwest to southwest winds, easing from later Saturday.

#### Lower South East District:

Partly cloudy. Very high (90%) chance of showers, most likely in the morning. The chance of a storm. Winds northerly 20 to 30 km/h.

Friday. Cloudy. High (80%) chance of showers, most likely in the morning and afternoon. The chance of a storm. Winds north to northeasterly 15 to 25 km/h becoming light during the evening.

### VICTORIA:

#### South West District:

Cloudy. Very high (95%) chance of showers. The chance of a storm in the west in the morning. Winds northerly 20 to 30 km/h.

Friday. Partly cloudy. Medium (60%) chance of showers. The chance of a storm. Winds north to northeasterly 15 to 25 km/h.

## COONAWARRA FORECAST



**TODAY**  
Showers easing. **16**



**TOMORROW**  
Showers. **16**



**SATURDAY**  
Showers. **15**



**SUNDAY**  
Showers. **16**



Sunny

Mostly sunny

Partly cloudy

Cloudy

Chance shower

Shower or two

Showers

Light rain (drizzle)

Rain

Storm

Showers storm

Windy

Dust

Fog

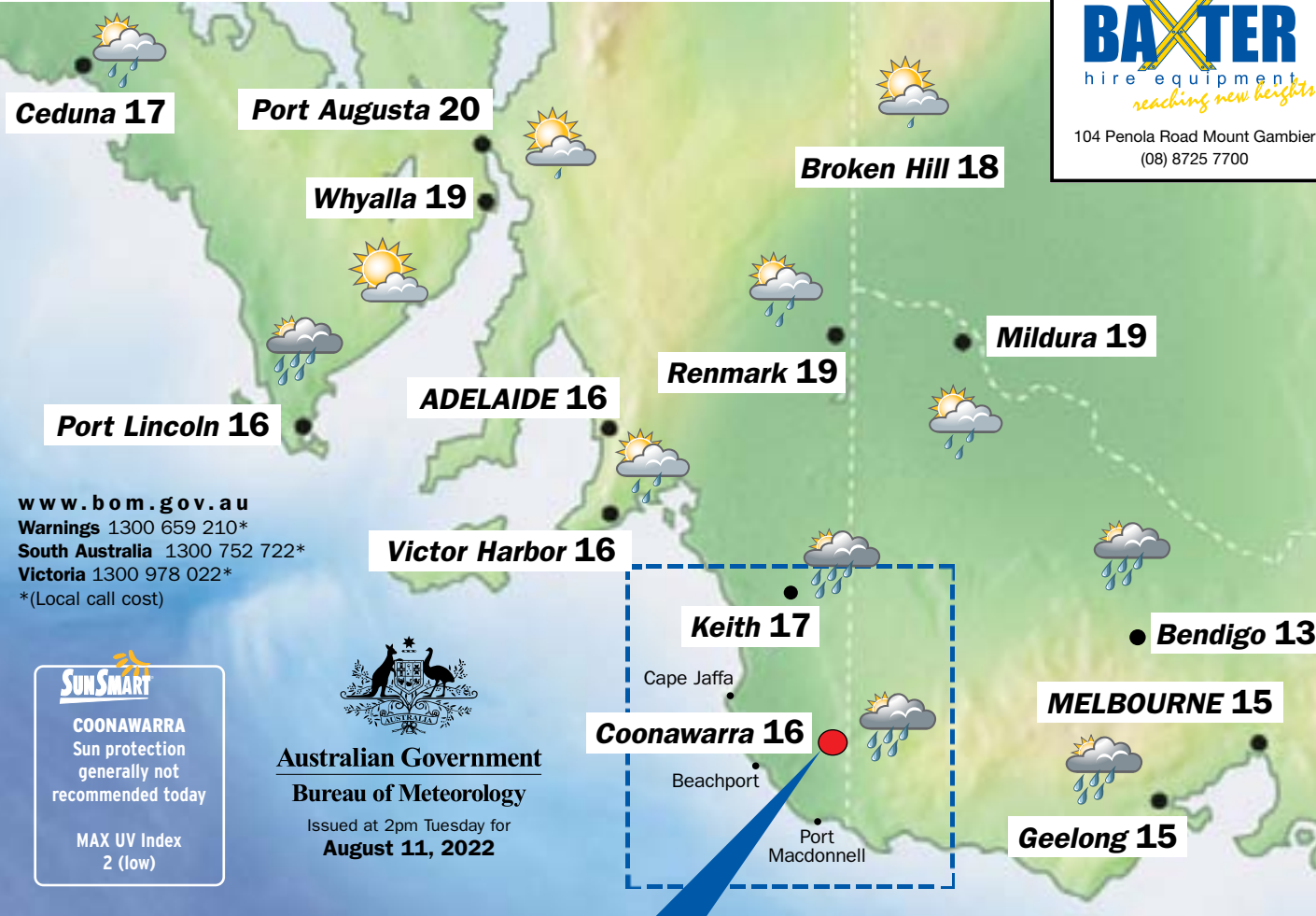

[www.bom.gov.au](http://www.bom.gov.au)  
Warnings 1300 659 210\*  
South Australia 1300 752 722\*  
Victoria 1300 978 022\*  
\*(Local call cost)



**COONAWARRA**  
Sun protection generally not recommended today

MAX UV Index  
2 (low)

Australian Government  
Bureau of Meteorology  
Issued at 2pm Tuesday for  
August 11, 2022

ENJOY YOUR DAY WITH THIS PAGE BROUGHT TO YOU BY



104 Penola Road Mount Gambier  
(08) 8725 7700

### COASTAL WATERS

#### South Central Coastal Waters:

Winds: Northwesterly 20 to 30 knots. Seas: 2 to 2.5 metres. Swell: Westerly 2 to 3 metres, increasing to 3 to 4 metres west of Kangaroo Island.

Weather: Cloudy. 95% chance of showers. The chance of a storm.

#### Upper South East Coastal Waters:

Murray Mouth to Cape Jaffa  
Winds: Northerly 20 to 35 knots. Seas: 1 to 1.5 metres, increasing to 1.5 to 2.5 metres offshore. Swell: Westerly 1.5 to 2.5 metres.

Weather: Partly cloudy. 90% chance of showers. The chance of a thunderstorm.

#### Lower South East Coastal Waters:

Cape Jaffa to SA-Vic Border  
Winds: Northerly 20 to 30 knots, decreasing to around 20 knots during the evening. Seas: 2 to 3 metres, decreasing to 1 to 1.5 metres during the evening. Swell: Westerly 2 to 3 metres.

Weather: Cloudy. 95% chance of showers. The chance of a thunderstorm.

#### West Victoria Coastal Waters:

SA-Vic Border to Cape Otway  
Winds: Northerly 20 to 30 knots. Seas: 1.5 to 2.5 metres, decreasing to 1 metre during the evening. Swell: Westerly 1.5 to 2.5 metres.

Weather: Cloudy. 95% chance of showers. The chance of a storm.

### TODAY 10AM

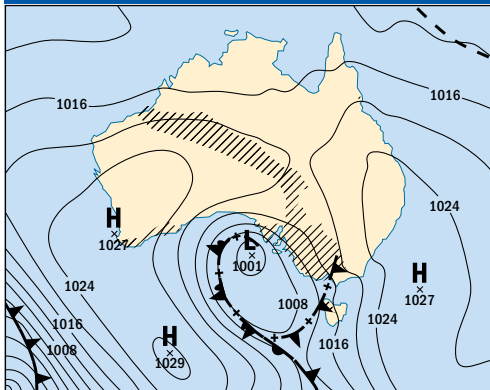

### TOMORROW 10AM

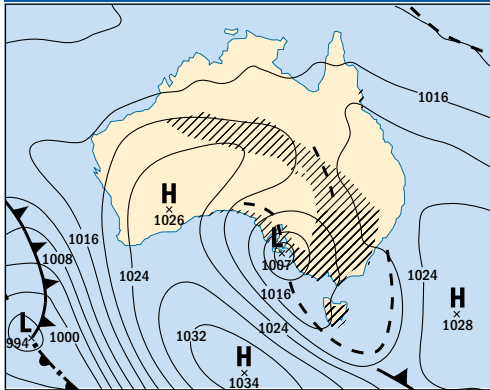

### SATURDAY 10AM

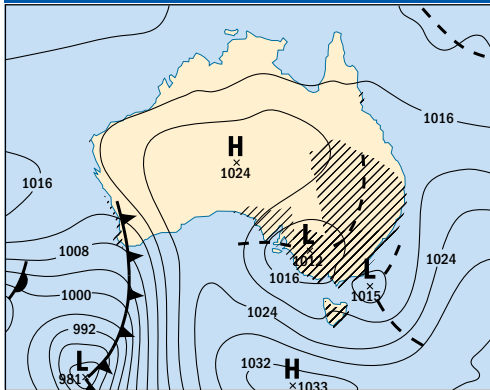

Forecast Rain 24 hrs to 9am  
— 1024 — hectoPascal (hPa)  
- - - - - trough  
▲ cold front  
▲ warm front

### COASTAL WATERS

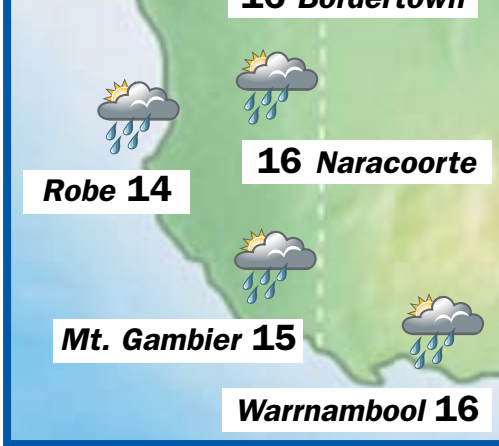

### TIDES

Beachport		
<b>Today:</b>		
L:	3:50am	0.7m
H:	12:36pm	1.6m
<b>Tomorrow:</b>		
L:	4:57am	0.7m
H:	1:02pm	1.6m
L:	8:46pm	0.9m
H:	11:56pm	0.9m
<b>Saturday:</b>		
L:	5:46am	0.6m
H:	1:23pm	1.5m
L:	8:30pm	0.9m
<b>Sunday:</b>		
H:	12:23am	1.0m
L:	6:26am	0.6m
H:	1:37pm	1.4m
L:	8:16pm	0.9m

### THE WORLD

World conditions yesterday			
City	Weather	Max	Min
Athens	fine	35	24
Auckland	fine	15	7
Bangkok	storms	34	25
Beijing	fine	30	20
Berlin	fine	29	14
Christchurch	fine	8	-3
Denpasar	cloudy	30	24
Dublin	sunny	26	15
Hong Kong	showers	29	26
Honolulu	sunny	31	24
Jakarta	cloudy	30	25
Johannesburg	fine	21	9
Kuala Lumpur	fine	34	24
London	sunny	28	17
Los Angeles	sunny	32	20
Madrid	cloudy	37	24
Moscow	rain	20	16
New Delhi	fine	36	26
New York	showers	26	25
Noumea	fine	22	18
Paris	sunny	32	18
Auckland	fine	15	7
Port Vila	showers	29	21
Seoul	rain	30	23
Singapore	storms	33	24
Suva	storms	28	20
Tel Aviv	fine	30	24
Tokyo	fine	36	27
Vancouver	showers	23	17
Wellington	windy	8	6

### CAPITAL CITIES

City	Condition	Max
Adelaide	Shower or two.	16
Brisbane	Partly cloudy.	21
Canberra	Possible shower.	14
Darwin	Mostly sunny.	32
Hobart	Possible shower.	15
Melbourne	Showers easing.	15
Perth	Partly cloudy.	19
Sydney	Cloudy.	19

### SUN & MOON

	Sunrise	Sunset	Moonrise	Moonset
Thursday	6:56am	5:28pm	4:18pm	6:29am
Friday	6:54am	5:29pm	5:36pm	7:15am
Saturday	6:53am	5:30pm	6:51pm	7:52am
Sunday	6:52am	5:31pm	8:02pm	8:24am
Monday	6:51am	5:32pm	9:10pm	8:52am
Tuesday	6:50am	5:32pm	10:15pm	9:18am



# YOUR WEEKLY TV GUIDE

## THE DOG HOUSE AUSTRALIA 10, Thursday, 7.30pm



If you're craving a feel-good show that isn't afraid to give an energetic pull on the heartstrings, this is the pick of the litter. Dogs are excellent for entertainment, but more often than not they are a much-needed balm for sadness. *The Living Room's* Dr Chris Brown is the perfect narrator for the stirring real-life stories of finding a doggie companion. Tonight, Marina and Dan are looking for a furry pal to help heal after the recent loss of Marina's dad. A scary health emergency and a long-held promise are behind the motivations of the Diconoski family finding a pooch for Tanisha, with a Staffordshire Terrier mix named Banksy (pictured) a shoo-in to be the newest member of their tight-knit clan.

## SCIENCE OF DRUGS WITH RICHARD ROXBURGH ABC TV, Tuesday, 9.30pm

*Rake's* Richard Roxburgh (pictured) arrives with both humour and gravitas as presenter of this irreverent four-part documentary series, delving into the history, harm and benefits of recreational drugs. Humans have employed mind-altering substances for a millennia, but today there are cut and dried rules. In tonight's premiere, Roxburgh and a crew of scientists unbuckle the facts and complications behind society's two most commonly used drugs: tobacco and alcohol. The long history of cigarettes is unravelled, while the consensus on alcohol is damning. You won't look at your glass of wine the same way again.



## THE STRANGER SBS, Wednesday, 9.25pm

Richard Armitage (pictured) will send shivers up your spine in this addictive thriller. Based on Harlan Coben's bestseller, jaw-dropping moments abound where loving father and husband Adam (Armitage) is engulfed by looks of pure fear and confusion. At times, the intensity is almost too much to take, but the excellent script and acting will propel any lover of nailbiting drama. Also starring *Absolutely Fabulous's* Jennifer Saunders in a stunning dramatic turn, this eight-part Netflix original explores what happens when a seemingly perfect life is interrupted by a stranger sharing unimaginable, devastating secrets.



WHAT'S ON THE BOX?

## PICK OF THE WEEK

### MY KITCHEN RULES Seven, Monday, 7.30pm

Unless you order takeaway daily or, lo and behold, have a private chef, there's no escaping the responsibility of cooking. As a result, many people like to rely on the classics: bolognese or tuna bake, perhaps even sweet and sour chicken. It's much the same with TV; sometimes you just want a trusty old favourite to count on. *My Kitchen Rules* is back after a two-year break with its 12th season. It's like the chicken schnitzel of cooking shows. The difference is, this season there's a fancy new side in the form of new judge Nigella Lawson, who joins Manu Feildel. Tune in for the state versus state cooking, which might tempt you to whip up something different in the kitchen.

## Thursday, August 11

### ABC TV (2)

**6.00** News Breakfast. **9.00** ABC News Mornings. **10.00** Back Roads. (PG, R) **10.30** That Pacific Sports Show. (R) **11.00** Rick Stein's Road To Mexico. (R) **12.00** ABC News At Noon. **1.00** Win The Week. (PG, R) **1.30** Shaun Micallef's MAD AS HELL. (M, R) **2.00** The Durrells. (Mv, R) **3.00** Escape From The City. (PG, R) **4.00** Think Tank. (PG, R) **4.55** Anh's Brush With Fame. (PG, R) **5.25** Hard Quiz. (PG, R)

**6.00** The Drum. **6.55** Sammy J. (PG) **7.00** ABC News. **7.30** 7.30. **8.00** Foreign Correspondent. International current affairs program. **8.30** Q+A. Public affairs program. **9.35** Courtney Act's One Plus One. Courtney Act speaks with Josh Cavallo. **10.05** ABC Late News. **10.20** The Business. (R) **10.35** 8 Nights Out West. **10.45** The Science Of Relationships: A Catalyst Special. (PG, R) **11.40** Baptiste. (Malv, R) **12.40** Wakefield. (Madl, R) **1.30** The Durrells. (Mv, R) **3.25** Rage. (MA15+adhlsv) **4.25** The Drum. (R) **5.20** Sammy J. (PG, R) **5.25** 7.30. (R)

**ABC TV PLUS (22)** **6am** Children's Programs. **5.55pm** Nella The Princess Knight. **6.05** The Adventures Of Paddington. **6.20** Bluey. **6.25** Little J And Big Cuz. **6.45** Andy's Prehistoric Adv. **7.00** Andy And The Band. **7.15** Obki. **7.20** Bluey. **7.30** Spicks And Specks. **8.30** Would I Lie To You? **9.00** Shaun Micallef's MAD AS HELL. **9.30** Win The Week. **10.00** Penn & Teller: Fool Us. **10.45** Mock The Week. **11.15** Doctor Who. **12.05am** Live From The BBC. **12.50** Would I Lie To You? **1.30** ABC News Update. **1.35** Close. **5.00** Clangers. **5.15** Hoot Hoot Go! **5.20** Sarah & Duck. **5.30** Guess How Much I Love You. **5.40** Late Programs.

**NITV (34)** **6am** Morning Programs. **10.00** Unknown Amazon. **10.50** Road Open. **11.00** Yokai Footy. **11.55** National Indigenous Fashion Awards. **12.55pm** Vogue Australia: Sixty Years Through The Lens. **1.45** Woman Who Returns. **2.00** Shortland St. **2.30** Kriol Kitchen. **3.00** Bushwhacked! **3.25** The Magic Canoe. **3.50** Wolf Joe. **4.00** Aussie Bush Tales. **4.10** Grace Beside Me. **4.35** Spartakus And The Sun Beneath The Sea. **5.00** Our Stories. **5.30** The 77 Percent. **6.00** Bamay. **6.30** News. **6.40** Unknown Amazon. **7.30** Going Places With Ernie Dingo. **8.30** Curious Australia. **9.30** MOVIE: Manganinnie. (1980, PG) **11.10** Late Programs.

### SBS (3)

**6.00** WorldWatch. **9.05** Home Is Where The Art Is. (PG) **10.00** Employable Me (USA) (PG) **10.50** Cook Up With Adam Liaw Bitesize. (R) **11.00** Soccer. FIFA U-20 Women's World Cup. Match 1. Costa Rica v Australia. **1.30** WorldWatch. **3.30** Destination Flavour China Bitesize. (R) **3.45** The Cook Up. (PG, R) **4.15** The Wonderful World Of Chocolate. (PG, R) **5.05** Jeopardy! (PG) **5.30** Letters And Numbers. (R)

**6.00** The Cook Up With Adam Liaw. (PG) **6.30** SBS World News. **7.35** World's Most Scenic River Journeys: River Dordogne. (PG) **8.30** Scotland's Sacred Islands With Ben Fogle: Inner Hebrides. (R) Part 1 of 4. **9.30** The Queen At War. (PGa, R) A look at the impact of war on Queen Elizabeth II. **10.30** SBS World News Late. **11.00** Gomorrah. (MA15+v) **11.55** Miniseries: Algiers Confidential. (MA15+as) **1.45** Baghdad Central. (MA15+av, R) **4.30** VICE Guide To Film. (MA15+d, R) **5.00** NHK World English News Morning. **5.30** ANC Philippines The World Tonight.

**SBS VICELAND (31)** **6am** WorldWatch. **8.40** Shortland St. **10.10** Alone. **11.20** VICE. **11.55** Devoured. **12.45pm** One Armed Chef. **1.35** One Star Reviews. **2.00** Small Town Secrets. **2.50** National Indigenous Fashion Awards. **3.50** ABC World News Tonight With David Muir. **4.15** PBS News. **5.15** Shortland St. **5.45** The Joy Of Painting With Bob Ross. **6.15** Forged In Fire. **7.05** Jeopardy! **7.35** 8 Out Of 10 Cats Does Countdown. **8.30** Curious Australia. **9.40** When Demolitions Go Wrong. **10.35** Betraying The Badge. **11.30** Limetown. **12.40am** Dark Side Of The Ring. **1.30** Cocaine: Britain's Epidemic. **2.25** NHK World English News. **5.00** Al Jazeera.

**SBS WORLD MOVIES (32)** **6am** Forever Enthralled. (2008, PG, Mandarin) **8.20** Selkie. (2000, PG) **10.00** Dust-Man. (2020, M, Korean) **11.40** Samson And Delilah. (2009, M) **1.30pm** Rosie. (2018, PG) **3.15** Mon Oncle. (1958, French) **5.20** Into The Arms Of Strangers. (2000, PG) **7.35** The Man Who Brought Down The White House. (2017, M) **9.30** Escape From Mogadishu. (2021, Korean) **11.50** Pipeline. (2021, MA15+, Korean) **1.50am** Beats. (2019, MA15+) **3.45** Lost In Paris. (2016, M) **5.20** The Man Who Brought Down The White House. (2017, M)

### SEVEN (6)

**6.00** Sunrise. **9.00** The Morning Show. (PG) **11.30** Seven Morning News. **12.00** My Kitchen Rules. (PG, R) **1.30** Surveillance Oz. (PG, R) **2.00** Kochie's Business Builders. **2.30** Border Patrol. (PG, R) **3.00** The Chase. (R) **4.00** Seven News At 4. **5.00** The Chase Australia.

**6.00** Seven News. **7.00** Home And Away. (PG) Lyrik bans inter-band romance. **8.30** The Front Bar. (M) Hosts Mick Molloy, Sam Pang and Andy Maher take a lighter look at the world of AFL. **9.30** Crime Investigation Australia: The Cangai Siege. (MA15+alv, R) Takes a look at the 1993 Cangai siege, the culmination of a murder spree that claimed the lives of five people. **10.55** Police Strike Force. (Mad, R) **12.00** Instant Hotel. (Ms, R) **1.15** Travel Oz. (PG, R) **2.00** Home Shopping. (R) **4.00** NBC Today. **5.00** Seven Early News. **5.30** Sunrise.

**7MATE (60)** **6am** ITM Fishing Show. **7.00** Step Outside With Paul Burt. **7.30** Creek To Coast. **8.15** America's Game: The Super Bowl Champions. **9.15** NFL 100 Greatest. **10.15** Storage Wars. **10.45** Pawn Stars. **11.15** American Pickers. **12.15pm** Demolition NZ. **1.15** Billion Dollar Wreck. **2.15** Billy The Exterminator. **3.15** Pawn Stars. **3.45** Shipping Wars. **4.15** Desert Collectors. **5.30** American Pickers. **6.30** Pawn Stars. **7.30** Storage Wars. **8.30** Pawn Stars. **9.30** American Pickers. **10.30** American Restoration. **11.30** Desert Collectors. **12.45am** Graveyard Carz. **3.45** S.W.A.T. **5.00** Timbersports.

**7TWO (62)** **6am** Home Shopping. **6.30** Travel Oz. **8.00** Harry's Practice. **8.30** Million Dollar Minute. **9.30** NBC Today. **Noon** Bargain Hunt. **1.00** Million Dollar Minute. **2.00** My Italian Family. **2.30** Sons And Daughters. **4.30** Emmerdale. **5.00** Coronation Street. **5.30** Escape To The Country. **6.30** Bargain Hunt. **7.30** Father Brown. **8.30** Murdoch Mysteries. **12.30am** The Fine Art Auction. **3.30** Our Town. **4.00** Harry's Practice. **4.30** Million Dollar Minute. **5.30** James Robison.

### NINE (8)

**6.00** Today. **9.00** Today Extra. (PG) **11.30** Morning News. **12.00** The Block. (PG, R) **1.00** After The Verdict. (Mlsv, R) **2.00** Pointless. (PG) **3.00** Tipping Point. (PG) **4.00** Millionaire Hot Seat. Hosted by Eddie McGuire. **5.00** Afternoon News.

**6.00** Nine News. **7.00** A Current Affair. **7.30** RBT. (PGadl, R) **8.30** Paramedics. (PGm, R) A flight paramedic races to help a student. **9.30** New Amsterdam. (Mam) Helen takes the reins at NHS Hampstead Hospital. **10.30** The Equalizer. (MA15+v) **11.20** Nine News Late. **11.50** Murder For Hire. (PGa) **12.40** Tipping Point. (PG, R) **1.30** TV Shop: Home Shopping. (R) **2.30** Global Shop. (R) **3.00** TV Shop: Home Shopping. (R) **4.00** Believer's Voice Of Victory. (PGa) **4.30** A Current Affair. (R) **5.00** News Early Edition. **5.30** Today.

**9GEM (81)** **6am** TV Shop: Home Shopping. **7.00** Creffo Dollar Ministries. **7.30** TV Shop: Home Shopping. **10.30** Pointless. **11.30** My Favorite Martian. **Noon** Days Of Our Lives. **12.55** The Young And The Restless. **1.50** The Bill. **3.00** MOVIE: Lady Godiva Rides Again. (1951) **5.00** Murder, She Wrote. **6.00** Antiques Roadshow. **7.00** Rugby League. NRL. Round 22. Penrith Panthers v Melbourne Storm. **9.20** Thursday Night Knock Off. **10.05** The Disappearance Of Crystal Rogers. **11.05** Law & Order: SVU. **12.05am** House. **1.00** TV Shop: Home Shopping. **4.30** Joyce Meyer. **5.00** TV Shop: Home Shopping.

**9GO! (82)** **6am** Children's Programs. **Noon** The Bionic Woman. **1.00** Buck Rogers. **2.00** Motor Racing. IndyCar Series. Music City Grand Prix. H'lights. **3.00** The Nanny. **3.30** 3rd Rock. **4.00** That '70s Show. **4.30** Raymond. **5.30** The Nanny. **6.00** 3rd Rock. **6.30** That '70s Show. **7.00** Young Sheldon. **8.30** MOVIE: Jupiter Ascending. (2015, M) **11.00** Motor Racing. TCR Australia Series, Trans Am Series and S5000 Australian Drivers Championship. Highlights. **1am** Love After Lockup. **2.00** Snapped. **2.50** Mike Tyson Mysteries. **3.00** Bakugan: Evolutions. **3.30** Ninjago. **4.00** TV Shop. **5.00** Late Programs.

### TEN (5)

**6.00** Entertainment Tonight. (R) **6.30** Good Chef Bad Chef. (R) **7.00** Judge Judy. (PG, R) **7.30** The Bold And The Beautiful. (PG, R) **8.00** 10 News First: Breakfast. **8.30** Studio 10. (PG) **12.00** Dr Phil. (PGa) **1.00** To Be Advised. **2.00** Entertainment Tonight. **2.30** Farm To Fork. (PG, R) **3.00** Judge Judy. (PG, R) **3.30** My Market Kitchen. **4.00** Everyday Gourmet With Justine Schofield. **4.30** The Bold And The Beautiful. (PG) **5.00** 10 News First.

**6.30** The Project. A look at the day's news and events. **7.30** The Dog House Australia. (PGa) Narrated by Dr Chris Brown. **8.30** Law & Order: SVU. (Mas) When a schoolgirl goes missing, the squad must track down a trusted family friend for answers. **9.30** To Be Advised. **10.30** Law & Order: SVU. (Mas, R) The squad investigates an assault. **11.30** The Project. (R) **12.30** The Late Show With Stephen Colbert. (PG) **1.30** Home Shopping. (R) **4.30** CBS Mornings.

**10 BOLD (51)** **6am** Home Shopping. **8.00** The Doctors. **9.00** Escape Fishing With ET. **9.30** iFish. **10.00** MacGyver. **Noon** NCIS: New Orleans. **1.00** The Code. **2.00** Walker, Texas Ranger. **3.00** Cheers. **3.30** The Love Boat. **4.30** Star Trek: The Next Generation. **5.30** MacGyver. **7.30** NCIS. **8.30** Bull. **10.30** Elementary. **11.30** 48 Hours. **12.30am** Home Shopping. **2.00** Blue Bloods. **3.00** MacGyver. **5.00** The Doctors.

**10 PEACH (52)** **6am** The Late Show With Stephen Colbert. **7.00** Friends. **8.00** The King Of Queens. **9.00** Becker. **10.00** The Middle. **11.00** Friends. **Noon** The Living Room. **1.00** Frasier. **2.00** Becker. **3.00** The King Of Queens. **4.00** Becker. **5.00** Frasier. **6.00** Friends. **8.00** The Big Bang Theory. **9.30** Seinfeld. **11.00** Frasier. **Midnight** Home Shopping. **1.30** The Late Show With Stephen Colbert. **2.30** The Late Show With James Corden. **3.30** The King Of Queens. **4.30** Home Shopping.



# Friday, August 12

## ABC TV (2)

**6.00** News Breakfast. **9.00** ABC News Mornings. **10.00** Q+A. (R) **11.00** Escape From The City. (PG, R) **12.00** ABC News At Noon. **1.00** Mystery Road: Origin. (Final, Mlv, R) **2.00** Grantchester. (PG, R) **3.00** Escape From The City. (R) **4.00** Think Tank. (PG, R) **4.55** Anh's Brush With Fame. (PG, R) **5.25** Hard Quiz. (PG, R)

**6.00** The Drum. Analysis of the day's news. **7.00** ABC News. Takes a look at today's top stories. **7.30** Movin' To The Country. (Final, PG) The team heads to South Australia. **8.00** Joanna Lumley's Britain. (PG, R) Part 3 of 3. Joanna Lumley's most personal journey comes to an end, as she travels from North Wales to her home town of London. **8.50** Miniseries: Time. (Final, Malv) Part 3 of 3. Mark suffers a tragic personal loss and is given the chance to leave prison for a day. **9.55** Baptiste. (Final, Mlv, R) Julien and Genevieve outmanoeuvre Constantin. **10.55** ABC Late News. **11.10** 8 Nights Out West. **11.20** Shaun Micallef's MAD AS HELL. (M, R) **11.50** Aftertaste. (Ml, R) **12.20** Rage. (MA15+adhlinsv)

**ABC TV PLUS (22)** **6am** Children's Programs. **6.45pm** Andy's Prehistoric Adv. **7.00** Andy And The Band. **7.15** Obki. **7.20** Bluey. **7.30** Spicks And Specks. **8.00** Hard Quiz. **8.30** MOVIE: Across The Universe. (2007, M) **10.40** Doctor Who. **11.40** QI. **12.15am** GameFace. **1.35** Inside The Met. **2.35** ABC News Update. **2.40** Close. **5.00** Twirlywoos. **5.15** Hoot Hoot Go! **5.20** Pocoyo. **5.30** Guess How Much I Love You. **5.40** Late Programs.

**NITV (34)** **6am** Morning Programs. **1.40pm** Bamay. **2.00** Shortland St. **2.30** Red Chef Revival. **3.00** Jarjums. **4.35** Spartakus And The Sun Beneath The Sea. **5.00** Our Stories. **5.30** NITV News: Nula. **6.00** Bamay. **6.40** Unknown Amazon. **7.30** MOVIE: Lord Of The Flies. (1963, PG) **9.05** Bedtime Stories. **9.15** Through The Wormhole With Morgan Freeman. **10.05** Cultural Connections Immersion Festival. **11.05** Late Programs.

## SBS (3)

**6.00** WorldWatch. **9.00** Cook Up With Adam Liaw Bitesize. (R) **9.15** Home Is Where The Art Is. (PG) **10.05** Employable Me (USA) (PG) **10.55** Icons. (PG) **11.55** Cook Up With Adam Liaw Bitesize. (R) **12.00** WorldWatch. **2.05** Youth On Strike! (Ml, R) **3.00** NITV News: Nula. (R) **3.45** The Cook Up. (PG, R) **4.15** The Wonderful World Of Chocolate. (PG, R) **5.05** Jeopardy! (PG) **5.30** Letters And Numbers. (R)

**6.00** The Cook Up With Adam Liaw. (PG) **6.30** SBS World News. **7.35** Lost Treasures Of Ancient Rome: Pompeii. (Premiere) Archaeologists embark on new digs in Pompeii. **8.30** Ross Kemp: Shipwreck Treasure Hunter: The U-Boat Terror. Part 1 of 4. Ross Kemp explores shipwrecks around the UK beginning with a visit to the Scapa Flow. **9.20** World's Most Scenic Railway Journeys: Finland. (R) Narrated by Bill Nighy. **10.20** SBS World News Late. **10.50** Shadow Lines. (MA15+av) **2.10** Miniseries: The Unusual Suspects. (Mdl, R) **4.05** 8 Out Of 10 Cats Does Countdown. (Mals, R) **5.00** NHK World English News Morning. **5.30** ANC Philippines The World Tonight.

**SBS VICELAND (31)** **6am** WorldWatch. **8.40** Shortland St. **10.10** Alone. **11.20** VICE. **11.55** Tattoo Age. **12.55pm** Secrets Of America's Shadow Government. **1.50** Planet A. **2.20** Huang's World. **3.15** Feeding The Scrum. **3.45** WorldWatch. **5.15** Shortland St. **5.45** Joy Of Painting. **6.15** Forged In Fire. **7.05** Jeopardy! **7.35** 8 Out Of 10 Cats. **8.30** Hoarders. (Final) **9.20** Porn Addiction: The Great Flop. **10.35** Late Programs.

**SBS WORLD MOVIES (32)** **6am** Morning Programs. **7.15** Into The Arms Of Strangers. (2000, PG) **9.25** Mon Oncle. (1958, French) **11.35** Ellie And Abbie. (2020, M) **1.05pm** Lost In Paris. (2016, M) **2.40** Selkie. (2000, PG) **4.15** Asterix: The Mansions Of The Gods. (2014, PG, French) **5.50** Last Chance Harvey. (2008, PG) **7.30** Steel Magnolias. (1989) **9.40** Parasite. (2019, MA15+, Korean) **12.10am** Late Programs.

## SEVEN (6)

**6.00** Sunrise. **9.00** The Morning Show. (PG) **11.30** Seven Morning News. **12.00** MOVIE: Jesse Stone: Stone Cold. (2005, Masv) **2.00** Criminal Confessions: Canton, Pennsylvania. (Mav, R) **3.00** The Chase. (R) **4.00** Seven News At 4. **5.00** The Chase Australia.

**6.00** Seven News. **7.00** Football. AFL. Round 22. St Kilda v Brisbane Lions. From Marvel Stadium, Melbourne. **10.00** AFL Post-Game Show. A wrap-up of the game, including panel discussion and interviews, with access to players, coaches and staff. **10.30** Armchair Experts. (M) Adam Cooney, Cam Luke and Georgie Parker present their unique analysis of the week in AFL. **11.00** To Be Advised. **1.30** Harry's Practice. (R) Dr Harry Cooper and Dr Katrina Warren present information about animals and pet care. **2.00** Home Shopping. (R) **4.00** Million Dollar Minute. (R) Hosted by Simon Reeve. **5.00** NBC Today. News and current affairs.

**7MATE (60)** **6am** Morning Programs. **1pm** Billion Dollar Wreck. **2.00** Bull Riding. PBR Aust. Monster Energy Tour. PBR Origin Brisbane. Replay. **2.30** Freesurfer. **3.00** Timbersports. **3.30** Shipping Wars. **4.00** Aussie Lobster Men. **5.00** Storage Wars. **5.30** American Pickers. **6.30** AFL: Friday Night Countdown. **7.00** Pawn Stars. **7.30** MOVIE: Father Of The Bride. (1991) **9.45** MOVIE: Lethal Weapon 3. (1992, M) **12.15am** Late Programs.

**7TWO (62)** **6am** Morning Programs. **8.00** Harry's Practice. **8.30** Million Dollar Minute. **9.30** NBC Today. **Noon** Bargain Hunt. **1.00** Million Dollar Minute. **2.00** South Aussie With Cosi. **2.30** Sons And Daughters. **4.30** Emmerdale. **5.00** Coronation Street. **5.30** Escape To The Country. **6.30** Border Security: Int. **7.00** Better Homes. **8.30** Escape To The Country. **9.30** Billy Connolly: Great American Trail. **10.40** Late Programs.

## NINE (8)

**6.00** Today. **9.00** Today Extra. (PG) **11.30** Morning News. **12.00** MOVIE: A Love To Remember. (2021, PGa) **1.45** Garden Gurus Moments. (R) **2.00** Pointless. (PG) **3.00** Tipping Point. (PG) **4.00** Millionaire Hot Seat. (R) **5.00** Afternoon News.

**6.00** Nine News. **7.00** A Current Affair. **7.30** Country House Hunters Australia. (Return) Hosted by Catriona Rowntree. **8.30** MOVIE: Hunter Killer. (2018, MA15+av, R) After the Russian president is kidnapped by an admiral who is launching a coup, an untested US submarine captain and a group of SEALs sets out to rescue him before the madman starts a war. Gerard Butler, Gary Oldman, Common. **10.55** MOVIE: Primal Fear. (1996, MA15+sv, R) A lawyer defends an altar boy. Richard Gere. **1.30** TV Shop: Home Shopping. (R) **4.00** Take Two. (R) **4.30** Global Shop. (R) **5.00** TV Shop: Home Shopping. (R) **5.30** Skippy The Bush Kangaroo. (R)

**9GEM (81)** **6am** Morning Programs. **11.30** My Favorite Martian. **Noon** Days Of Our Lives. **12.55** The Young And The Restless. **1.50** The Bill. **3.00** MOVIE: Saraband For Dead Lovers. (1948) **5.00** Murder, She Wrote. **6.00** Antiques Roadshow. **7.00** Rugby League. NRL. Round 22. Parramatta Eels v South Sydney Rabbitohs. **9.25** Golden Point. **10.05** MOVIE: Another 48 Hrs. (1990, M) **Midnight** Late Programs.

**9GO! (82)** **6am** Children's Programs. **Noon** The Bionic Woman. **1.00** Buck Rogers. **2.00** Young Sheldon. **3.00** The Nanny. **3.30** 3rd Rock. **4.00** That '70s Show. **4.30** Raymond. **5.30** MOVIE: Ella Enchanted. (2004, PG) **7.30** MOVIE: Bride Wars. (2009, PG) **9.20** MOVIE: What Happens In Vegas. (2008, M) **11.20** Up All Night. **11.50** Supergirl. **12.45am** Southern Charm. **2.50** Late Programs.

## TEN (5)

**6.00** Ent. Tonight. (R) **6.30** GCBC. (R) **7.00** Judge Judy. (PG, R) **7.30** Bold. (PG, R) **8.00** 10 News First: Breakfast. **8.30** Studio 10. (PG) **12.00** Dr Phil. (PGa) **1.00** The Living Room. (R) **2.00** Entertainment Tonight. **2.30** Food Trail: South Africa. (R) **3.00** Judge Judy. (PG, R) **3.30** My Market Kitchen. **4.00** Everyday Gourmet With Justine Schofield. **4.30** The Bold And The Beautiful. **5.00** 10 News First.

**6.30** The Project. The hosts and guest panellists take a look at the day's news, events and hot topics. **7.30** The Living Room. Stylist Chyka Keebaugh helps Barry Du Bois with a rental makeover. Miguel Maestre makes Italian inspired woodfired pizza at home. Dr Chris Brown builds a home among the gumtrees for some furry friends. **8.40** To Be Advised. **10.40** Just For Laughs Australia. (Mls, R) Stand-up comedy performance featuring Brodi Snook, Alice Fraser and Harley Breen. **11.40** The Project. (R) The hosts and guest panellists take a look at the day's news, events and hot topics. **12.40** The Late Show With Stephen Colbert. (PG) Late-night talk show. **1.30** Home Shopping. (R)

**10 BOLD (51)** **6am** Home Shopping. **8.00** The Doctors. **9.00** Escape Fishing With ET. **9.30** iFish. **10.00** MacGyver. **Noon** NCIS: New Orleans. **1.00** The Code. **2.00** Walker, Texas Ranger. **3.00** Cheers. **3.30** The Love Boat. **4.30** Star Trek: The Next Generation. **5.30** MacGyver. **7.30** NCIS. **8.30** Blue Bloods. **10.20** Evil. **11.15** Star Trek: Discovery. **12.15am** Home Shopping. **2.15** The Code. **3.10** MacGyver. **5.00** The Doctors.

**10 PEACH (52)** **6am** The Late Show With Stephen Colbert. **7.00** The Middle. **7.30** Seinfeld. **9.00** Becker. **10.00** The Middle. **11.30** Frasier. **Noon** The Dog House Australia. **1.00** Friends. **1.30** Seinfeld. **3.00** The King Of Queens. **4.00** Becker. **5.00** Frasier. **6.00** Friends. **8.00** The Big Bang Theory. **9.30** Mom. **10.30** Charmed. **11.30** Frasier. **Midnight** Shopping. **1.30** Stephen Colbert. **2.30** Late Programs.



# Trouble Sleeping?

Free Gifts Worth \$600.00

Got Back Pain? Neck Pain? Can't Get A Good Night's Sleep?

- Relaxing Vibrating Massage
- Fully Adjustable Height
- Split Bed Options

Call Now! 1800 440 440



# Saturday, August 13

## ABC TV (2)

**6.00** Rage. (PG) **7.00** Weekend Breakfast. **9.00** Rage. (PG) **12.00** ABC News At Noon. **12.30** Vera. (Mav, R) **2.00** Midsomer Murders. (PG, R) **3.35** Great Southern Landscapes. (PG, R) **4.05** Spicks And Specks. (PG, R) **4.55** Landline. (R) **5.25** Singapore's Secret Forests With David Attenborough. (R)

**6.10** Extraordinary Escapes: Alison Steadman. (PG, R) Sandi Toksvig and Alison Steadman explore Suffolk. **7.00** ABC News. Takes a look at today's top stories. **7.30** Grantchester. (Mv) A member of Will's congregation is murdered. **8.20** Endeavour. (Mav, R) Part 2 of 3. As campaigning for the 1970 general election gets underway in Oxford, racial tensions escalate in the city. **9.50** Mystery Road: Origin. (Final, Mlv, R) The Kelly Gang's plans come to a head. **10.45** 8 Nights Out West. **10.55** MOVIE: Suffragette. (2015, Malv, R) Carey Mulligan. **12.40** Rage. (MA15+adhlinsv)

**ABC TV PLUS (22)** **6am** Children's Programs. **7.10pm** Shaun The Sheep. **7.20** Bluey. **7.30** Spicks And Specks. **8.00** QI. **8.30** Live From The BBC. **9.15** Sammy J. **9.20** The Stand Up Sketch Show. **9.45** Whose Line Is It Anyway? **10.10** Would I Lie To You? **10.40** Doctor Who. **11.25** Friday Night Dinner. **11.50** Brassic. **12.35am** David Attenborough's Galapagos. **1.25** Black Books. **1.50** ABC News Update. **1.55** Close. **5.00** Late Programs.

**NITV (34)** **6am** Morning Programs. **12.25pm** Cultural Connections Immersion Festival. **1.25** Yothu Yindi Tribute Concert. **2.35** Hockey. WA Men's Field Hockey. Premier Division 1. **4.05** Hockey. WA Women's Field Hockey. Premier Division 1. **5.35** Small Business Secrets. **6.05** Strait To The Plate. **6.35** News. **6.45** The Casketeers. **7.15** First Australians. **8.30** The Wrestlers. **9.30** MOVIE: Manganinnie. (1980, PG) **11.10** Late Programs.

## SBS (3)

**6.00** WorldWatch. **9.05** Love Your Garden. (PG) **10.05** Great Canal Journeys. (PG) **11.00** Paul O'Grady: For The Love Of Dogs. (PG) **12.00** WorldWatch. **2.00** Building The Channel Tunnel. (PG, R) **3.00** FIFA World Cup 2022 Magazine. **3.30** Countdown To Qatar 2022. **4.05** Trail Towns. (R) **4.35** The Pyramids: Solving The Mystery. (R) **5.30** Hell On Earth: WWII. (PG)

**6.30** SBS World News. **7.35** World's Most Scenic Railway Journeys. (PG) **8.30** Secrets Of The Tower Of London. (PGav, R) Takes a look at the Tower of London. **9.20** Gone Fishing With Mortimer & Whitehouse. **10.25** Supreme Revenge: Battle For The Court. (Mas, R) **11.25** MOVIE: Lion. (2016, PGa, R) Dev Patel, Nicole Kidman. **1.30** MOVIE: The Happy Prince. (2018, MA15+, R) Rupert Everett. **3.30** 8 Out Of 10 Cats Does Countdown. (Mals, R) **4.25** VICE Guide To Film. (Mdlv, R) **4.50** Destination Flavour: Singapore Bitesize. (PGaw, R) **5.00** Soccer. FIFA U-20 Women's World Cup. Match 10. Australia v Brazil.

**SBS VICELAND (31)** **6am** WorldWatch. **8.40** Bamay. **9.00** Basketball. WNBA. Atlanta Dream v New York Liberty. **11.00** Abandoned. **11.50** Nirvana. **1.45pm** Noisy. **2.35** Over The Black Dot. **3.05** Yokay! Footy. **4.00** WorldWatch. **5.30** Insight. **6.30** Domino Masters. **7.30** Impossible Engineering. **8.30** The Public Image Is Rotten. **10.30** Hoarders. **1am** South Park. **2.30** NHK World English News. **5.00** Al Jazeera.

**SBS WORLD MOVIES (32)** **6am** Morning Programs. **8.25** Asterix: The Mansions Of The Gods. (2014, PG, French) **10.00** The Red Turtle. (2016, PG, No dialogue) **11.30** The Man Who Brought Down The White House. (2017, M) **1.25pm** Into The Arms Of Strangers. (2000, PG) **3.35** Raid. (2018, PG, Hindi) **5.50** Bugsy Malone. (1976, PG) **7.30** Les Misérables. (1998) **10.00** Hemel. (2012, MA15+, Dutch) **11.30** Late Programs.

## SEVEN (6)

**6.00** NBC Today. **7.00** Weekend Sunrise. **10.00** The Morning Show: Weekend. (PG) **12.00** Dog Patrol. (PG, R) **12.30** Highway Patrol. (PG, R) **1.00** The Crows Show. **1.30** Football. AFL. Round 22. Adelaide v North Melbourne. From Adelaide Oval. **4.30** Border Security: Australia's Front Line. (PG, R) **5.00** Seven News Adelaide. **5.30** Discover With RAA Travel. (PG)

**6.00** Seven News. **6.55** Football. AFL. Round 22. Melbourne v Carlton. From the MCG. **10.00** AFL Post-Game Show. A wrap-up of the game, including panel discussion and interviews, with access to players, coaches and staff. **10.30** To Be Advised. **12.15** MOVIE: Rites Of Passage. (1999, Mv, R) A father and his two sons are terrorised by two escaped criminals in their mountain retreat. Dean Stockwell, Jason Behr, Robert Glen Keith. **2.00** Home Shopping. (R) **4.00** It's Academic. (R) Hosted by Simon Reeve. **5.00** Million Dollar Minute. (R) Hosted by Simon Reeve.

**7MATE (60)** **6am** Morning Programs. **1pm** Blokesworld. **1.30** Wheelburn. **2.00** Boating. UIM Class-1 World Powerboat C'ship. St Pete Grand Prix. Replay. **3.00** Rides Down Under: Workshop Wars. **4.00** Pawn Stars. **4.30** Last Car Garage. **5.00** American Pickers. **6.00** AFL Pre-Game. **6.30** Football. AFL. Round 22. Melbourne v Carlton. **6.55** Border Security. **7.30** MOVIE: Avengers: Infinity War. (2018, M) **10.35** Late Programs.

**7TWO (62)** **6am** Home Shopping. **8.30** Travel Oz. **10.00** Australia: The Story Of Us. **11.00** To Be Advised. **11.30** Horse Racing. PB Lawrence Stakes Day. Royal Randwick Race Day. Saturday Race Day. **4.30pm** RSPCA Animal Rescue. **5.00** Border Patrol. **5.30** The Yorkshire Vet. **8.30** Escape To The Country. **10.30** I Escaped To The Country. **11.30** The Yorkshire Vet. **1.30am** The Fine Art Auction. **4.30** Late Programs.

## NINE (8)

**6.00** Getaway. (PG, R) **6.30** A Current Affair. (R) **7.00** Weekend Today. **10.00** Today Extra: Saturday. (PG) **12.00** Surfing Australia TV. **12.30** Everything Outdoors. (R) **1.00** Animal Embassy. (PGm, R) **1.30** Arctic Vets. (PGm) **2.00** The Block. (PGl, R) **4.30** Good Chef Hunting. **5.00** News: First At Five. **5.30** Getaway. (PG)

**6.00** Nine News Saturday. **7.00** A Current Affair. **7.30** After The Verdict. (Mlsv, R) Four jurors begin to doubt their decision. **8.30** MOVIE: My Big Fat Greek Wedding 2. (2016, PGs, R) A Greek-American woman tries to help organise an impromptu wedding for her family. Nia Vardalos, John Corbett, Michael Constantine. **10.25** MOVIE: Moonstruck. (1987, PGal, R) Cher. **12.20** A+E After Dark. (Mlm, R) **1.10** Animal Embassy. (PGm, R) **1.35** Surfing Australia TV. (R) **2.00** TV Shop: Home Shopping. (R) **4.30** Global Shop. (R) **5.00** TV Shop: Home Shopping. (R) **5.30** Skippy The Bush Kangaroo. (R)

**9GEM (81)** **6am** Morning Programs. **Noon** My Favorite Martian. **12.30** Explore. **12.40** MOVIE: The Sleeping Tiger. (1954, PG) **2.30** MOVIE: Arabian Adventure. (1979) **4.30** MOVIE: 633 Squadron. (1964, PG) **6.30** Rugby League. NRL. Round 22. Brisbane Broncos v Newcastle Knights. **9.00** NRL Saturday Night Footy Post-Match. **9.20** MOVIE: Get Shorty. (1995, MA15+) **11.30** Late Programs.

**9GO! (82)** **6am** Children's Programs. **1.30pm** Raymond. **2.00** Motor Racing. IndyCar Series. 106th Running of the Indianapolis 500. H'lights. **3.05** Motor Racing. IndyCar Series. Music City Grand Prix. H'lights. **4.15** The Channel: The World's Busiest Waterway. **5.15** Mr Mayor. **5.45** MOVIE: Smurfs: The Lost Village. (2017) **7.30** MOVIE: King Kong. (2005, M) **11.05** Paranormal Caught On Camera. **Midnight** Late Programs.

## TEN (5)

**6am** Morning Programs. **8.30** What's Up Down Under. (R) **9.00** Australia By Design: Architecture. (PG, R) **9.30** St10. (PG) **12.00** Luxury Escapes. (R) **12.30** My Market Kitchen. (R) **12.50** Living Room. (R) **2.00** Pooches At Play. **2.30** Freshly Picked. (R) **3.00** Roads Less Travelled. (R) **3.30** Farm To Fork. (PG, R) **4.00** Taste Of Aust. (R) **4.30** Food Trail: South Africa. **5.00** News.

**6.00** Luxury Escapes. Sophie Falkiner heads to Fiji. **6.30** Wildlife Rescue Australia. (PGm) An echidna has arrived for a check-up. **7.30** The Dog House Australia. (PGa, R) Narrated by Dr Chris Brown. **8.30** The Dog House. (PG, R) Follows a team of devoted matchmakers as they pair homeless dogs with hopeful companions. **9.30** Ambulance. (Mal, R) The North West Ambulance Service is facing one of its busiest nights of the year. **10.30** To Be Advised. **11.30** NCIS. (Mav, R) **1.30** Home Shopping. (R) **4.30** Authentic. (PG) **5.00** Hour Of Power.

**10 BOLD (51)** **6am** Home Shopping. **9.00** The Doctors. **10.00** Bondi Rescue. **11.00** Australia By Design: Innovations. **11.30** Healthy Homes Australia. **Noon** The Love Boat. **1.00** Star Trek: The Next Generation. **2.00** MacGyver. **4.00** Cheers. **4.30** Waltzing Jimeoin. **5.00** Reel Action. **5.30** Scorpion. **7.30** NCIS. **8.30** NCIS: Los Angeles. **10.20** Blood And Treasure. **11.15** 48 Hours. **12.15am** Blue Bloods. **2.05** Late Programs.

**10 PEACH (52)** **6am** The Late Show With Stephen Colbert. **7.00** The King Of Queens. **8.00** Frasier. **9.00** Becker. **10.00** Friends. **Noon** The King Of Queens. **1.00** Frasier. **1.30** To Be Advised. **5.00** Friends. **6.00** The Big Bang Theory. **10.15** Friends. **12.15am** Home Shopping. **1.45** Mom. **2.35** The Big Bang Theory. **3.30** Charmed. **4.30** Home Shopping.



# Sunday, August 14

## ABC TV (2)

**6.00** Rage. (PG) **7.00** Weekend Breakfast. **9.00** Insiders. **10.00** Offsiders. **10.30** World This Week. (R) **11.00** Compass. (PG, R) **11.30** Praise. (R) **12.00** News. **12.30** Landline. **1.30** Movin' To The Country. (Final, PG, R) **2.00** Dream Gardens. (R) **2.30** Muster Dogs. (R) **3.30** Rick Stein's Road To Mexico. (PG, R) **4.30** Win The Week. (PG, R) **5.00** Art Works. (R) **5.30** Antiques Roadshow. (R)

**6.30** Compass: Indira's Tree. (PG, R) Indira Naidoo opens up about a personal loss. **7.00** ABC News Sunday. **7.40** Spicks And Specks. (PG) Hosted by Adam Hills. **8.30** MOVIE: Here Out West. (2022, Malv) A baby is kidnapped from a western Sydney hospital by a desperate grandmother. Genevieve Lemon, Mia-Lore Bayeh, Christian Ravello. **10.10** 8 Nights Out West. (Final) Presented by Arka Das. **10.25** Miniseries: The War Of The Worlds. (Mv, R) **11.20** The Capture. (Mlv, R) **12.15** Fires. (Mal, R) **1.10** Wakefield. (Mal, R) **2.05** Rage. (MA15+adhlsv) **4.00** Classic Countdown. (PG, R) **5.00** Insiders. (R)

**ABC TV PLUS (22)** **6am** Children's Programs. **7.10pm** Shaun The Sheep. **7.20** Bluey. **7.30** Compass. **8.00** You Can't Ask That. **8.30** Louis Theroux: Miami Mega Jail. **9.35** The Science Of Relationships: A Catalyst Special. **10.30** Jeffrey Smart. **11.30** MOVIE: Across The Universe. (2007, M) **1.35am** George Clarke's Amazing Spaces. **2.25** ABC News Update. **2.30** Close. **5.00** Clangers. **5.15** Late Programs.

**NITV (34)** **6am** Morning Programs. **12.30pm** The Rising. **1.00** Rugby Union. Ella 7s. **1.30** VICE Sports. **2.00** Away From Country. **3.00** Rugby League. NRL NT. **4.30** Rugby League. NRL. WA Womens First Grade Premiership League. **6.00** Elements. **6.30** News. **6.40** Natural Born Rebels. **7.40** Who Killed Malcolm X. **8.30** Bruce Lee: Martial Arts Master. **9.30** MOVIE: Jackie Chan's First Strike. (1996, M) **11.30** Late Programs.

## SBS (3)

**6.00** Soccer. FIFA U-20 Women's World Cup. Match 10. Australia v Brazil. Continued. **7.30** Morning Programs. **10.05** Great Canal Journeys. (PG) **11.00** Paul O'Grady: For The Love Of Dogs. (PG) **12.00** WorldWatch. **12.30** Motorcycle Racing. ProMX Championship. Round 7. **3.30** WorldWatch. **4.00** Countdown To Qatar 2022. **5.00** The Great Pyramid Race. (R) **5.30** Hell On Earth: WWII. (PG)

**6.30** SBS World News. **7.35** Treasures Of Greece. (PGav, R) Bettany Hughes explores Athens. **8.30** Druids: The Mystery Of Celtic Priests. (PG, R) Takes a look at how new archaeological findings have shed a light on the lives of druids in Celtic culture. **9.30** Top Ten Treasures Of Pompeii. (Mans, R) Professor Bettany Hughes presents a countdown of Pompeii's 10 greatest treasures. **11.15** Vaccine: The Inside Story. (Ma, R) **1.00** Why We Hate. (Mav, R) **3.25** 8 Out Of 10 Cats Does Countdown. (Mals, R) **4.20** VICE Guide To Film. (Mlv, R) **4.50** Destination Flavour: Singapore Bitesize. (PGav, R) **5.00** NHK World English News Morning. **5.15** France 24 Feature. **5.30** Al Jazeera News.

**SBS VICELAND (31)** **6am** WorldWatch. **8.40** Shortland St. **10.10** Alone. **11.20** VICE. **11.55** Polygamy: Three Wives, One Husband. **12.50pm** Vice Essentials Canada. **1.20** Reset. **1.50** VICE. **2.25** Marry Me, Marry My Family. **3.30** WorldWatch. **4.00** Insight. **5.00** The Pizza Show. **5.30** Life After People. **6.25** Scandinavian Star. **7.35** Abandoned Engineering. **8.30** The UnXplained. **9.20** MOVIE: Miles Ahead. (2015, M) **11.10** Late Programs.

**SBS WORLD MOVIES (32)** **6am** Raid. Continued. (2018, PG, Hindi) **8.00** Buggy Malone. (1976, PG) **9.40** A United Kingdom. (2016, PG) **11.45** Children... (2011, M, Korean) **2.10pm** The Red Turtle. (2016, PG, No dialogue) **3.40** Last Chance Harvey. (2008, PG) **5.20** Long Way North. (2015, PG) **6.50** Sometimes Always Never. (2018, PG) **8.30** Am Sam. (2001) **11.05** Chaplin. (1992, M) **1.45am** Canopy. (2013, M) **3.15** Late Programs.

## SEVEN (6)

**6.00** NBC Today. **7.00** Weekend Sunrise. **10.00** The Morning Show: Weekend. (PG) **12.00** Better Homes And Gardens. (R) **1.00** Highway Patrol. (PG, R) **1.30** Football. SANFL. Round 18. South Adelaide v Port Adelaide. **4.00** Football. AFL. Round 22. Essendon v Port Adelaide.

**6.00** Seven News. **7.00** My Kitchen Rules. (PG) Hosted by Manu Feildel and Nigella Lawson. **8.30** 7NEWS Spotlight. Takes a look at an investigation. **9.30** Homicide: With Ron Iddles: Terry Floyd. (PG, R) Former police detective Ron Iddles looks into the unsolved 1975 disappearance of Terry Floyd. **10.40** Undercurrent: Real Murder Investigation. (Mav, R) A look into the disappearance of Bob Chappell. **11.45** Killer Tapes: The Murder Of Becky Watts. (Malv, R) **12.45** Crash Investigation Unit: Tunnel. (PG, R) **2.00** Home Shopping. (R) **3.30** Million Dollar Minute. (R) **4.00** NBC Today. **5.00** Seven Early News. **5.30** Sunrise.

**7MATE (60)** **6am** Morning Programs. **1pm** Hook, Line And Sinker. **2.00** On The Fly. **2.30** Merv Hughes Fishing. **3.00** Big Easy Motors. **3.30** Storage Wars. **4.00** Fishing Addiction. **5.00** American Pickers. **6.00** Football. AFL. Round 22. Essendon v Port Adelaide. **7.00** MOVIE: Harry Potter And The Half-Blood Prince. (2009, PG) **10.15** MOVIE: The Man From U.N.C.L.E. (2015, M) **12.40am** Late Programs.

**7TWO (62)** **6am** Morning Programs. **10.00** Australia: The Story Of Us. **11.00** NBC Today. **Noon** The Yorkshire Vet. **1.00** The Great Australian Doorstep. **1.30** Discover With RAA Travel. **2.00** The Bowls Show. **3.00** To Be Advised. **3.30** My Italian Family. **4.00** Escape To The Country. **6.00** Cities Of The Underworld. **7.00** Border Security. **8.30** Chris Tarrant's Extreme Railways. **9.30** Mighty Trains. **10.30** Train Truckers. **11.30** Late Programs.

## NINE (8)

**6.00** Arctic Vets. (PGm, R) **6.30** A Current Affair. **7.00** Weekend Today. **10.00** The AFL Sunday Footy Show. (PG) **12.00** Sports Sunday. (PG) **1.00** Bondi Lifeguard World Adventures. (PG, R) **1.30** Country House Hunters Australia. (R) **2.30** The Block. (Pgl, R) **5.00** News: First At Five. **5.30** Hello SA. (PG)

**6.00** Nine News Sunday. **7.00** The Block. (Pgl) Hosted by Scott Cam. **8.40** 60 Minutes. Current affairs program, investigating, analysing and uncovering the issues affecting all Australians. **9.40** Nine News Late. Takes a look at the latest news and events from Australia and around the world. **10.10** After The Verdict. (Mlsv, R) Four jurors begin to doubt their decision. **11.05** Suspect Number 1: Truth And Lies. (Mdlv) Police raid a cannabis factory. **12.00** First Responders. **12.50** Good Chef Hunting. (R) **1.20** Explore: Well Bread. (R) **1.30** TV Shop: Home Shopping. (R) **4.00** Believer's Voice Of Victory. (PGa) **4.30** Take Two. (R) **5.00** News Early Edition. **5.30** Today.

**9GEM (81)** **6am** Morning Programs. **7.30** In Touch. **8.00** Beyond Today. **8.30** The Incredible Journey. **9.00** Footy SA. **9.30** TV Shop. **10.00** My Favorite Martian. **10.30** NRL Sunday Footy Show. **12.30pm** MOVIE: Up Jumped A Swagman. (1965) **2.30** Rugby League. NRL. Round 22. Gold Coast Titans v Manly Sea Eagles. **5.30** Getaway. **6.00** Arctic Vets. **6.30** Bondi Vet. **7.30** To Be Advised. **11.30** Late Programs.

**9GO! (82)** **6am** Children's Programs. **1.30pm** Surfing Australia TV. **2.00** Motor Racing. SpeedSeries. TCR Aust Touring Car Series. Replay. **3.50** Say Yes To The Dress: UK. **4.50** Full House. **5.20** MOVIE: Lemony Snicket's A Series Of Unfortunate Events. (2004, PG) **7.30** MOVIE: Passengers. (2016, M) **9.45** MOVIE: Super 8. (2011, M) **Midnight** Rise. **1.00** Below Deck. **2.50** Late Programs.

## TEN (5)

**6am** Morning Programs. **7.30** Joel Osteen. **8.00** My Market Kitchen. (R) **8.20** Living Room. (R) **9.30** St10. (PG) **12.00** Freshly Picked. (R) **12.30** Everyday Gourmet. (R) **1.00** To Be Advised. **2.00** Pooches At Play. (R) **2.30** Luxury Escapes. (R) **3.00** Australia By Design: Innovations. (PG) **3.30** My Market Kitchen. (R) **4.00** Farm To Fork. (PG, R) **4.30** Taste Of Aust. (R) **5.00** News.

**6.30** The Sunday Project. A look at the day's news. **7.30** The Masked Singer Australia. Abbie Chatfield, Chrissie Swan, Dave Hughes and Mel B try to guess a celebrity singer's identity. **8.30** NCIS: Hawai'i. (Mv) When evidence is stolen, Lucy goes undercover at a poker tournament to find out which high-roller is behind the crime. Lucy's feelings are in turmoil when Whistler's ex-girlfriend arrives in town. **9.30** FBI. (Mv, R) The team investigates after a businessman with a history of harassment claims against him is killed. **11.30** The Sunday Project. (R) A look at the day's news. **12.30** Home Shopping. (R) **4.30** CBS Mornings.

**10 BOLD (51)** **6am** Home Shopping. **7.30** Key Of David. **8.00** The Doctors. **9.00** Healthy Homes Australia. **10.00** Bondi Rescue. **11.00** Reel Action. **Noon** Scorpion. **2.00** Tough Tested. **3.00** The Offroad Adventure Show. **4.00** Pooches At Play. **4.30** Waltzing Jimieoin. **5.00** iFish. **5.30** Bondi Rescue. **6.30** MacGyver. **7.30** NCIS. **10.20** 48 Hours. **11.15** Star Trek: Discovery. **12.10am** MOVIE: 21 Bridges. (2019, MA15+) **2.10** Late Programs.

**10 PEACH (52)** **6am** The Big Bang Theory. **6.30** Friends. **8.30** The Big Bang Theory. **10.30** Friends. **1.30pm** The Middle. **3.00** Friends. **5.00** Shaun Micallef's Brain Eisteddfod. **6.00** The Big Bang Theory. **10.30** To Be Advised. **11.30** Friends. **Midnight** Home Shopping. **1.30** Charmed. **2.30** Friends. **3.30** The Big Bang Theory. **4.30** Home Shopping.



# Trouble Sleeping?

**Got Back Pain? Neck Pain? Can't Get A Good Night's Sleep?**

- Relaxing Vibrating Massage
- Fully Adjustable Height
- Split Bed Options

**Call Now! 1800 440 440**

**Free Gifts Worth \$600.00**



**4x 8in1 Pillows**  
**1x Luxury Sheet Set**

\*Call for Terms & Conditions

# Monday, August 15

## ABC TV (2)

**6.00** News Breakfast. **9.00** ABC News Mornings. **10.00** Landline. (R) **11.00** Antiques Roadshow. (R) **12.00** ABC News At Noon. **1.00** Mum. (Final, Ml, R) **1.30** Vera. (Mav, R) **3.00** Escape From The City. (R) **4.00** Think Tank. (PG, R) **5.00** Anh's Brush With Fame. (PG, R) **5.25** Hard Quiz. (PG, R)

**6.00** The Drum. **7.00** ABC News. **7.30** 7.30. **8.00** Back Roads: Leonora, Western Australia. (PGa) Heather Ewart heads to Leonora. **8.30** Four Corners. Investigative journalism program. **9.20** Media Watch. (PG) Hosted by Paul Barry. **9.35** China Tonight. A look at current affairs from China. **10.05** ABC Late News. **10.20** The Business. (R) **10.40** Q+A. (R) **11.45** Miniseries: Time. (Malv, R) **12.50** Wakefield. (Malv, R) **2.45** Rage. (MA15+adhlsv) **4.25** The Drum. (R) **5.25** 7.30. (R)

**ABC TV PLUS (22)** **6am** Children's Programs. **7.15pm** Obki. **7.20** Bluey. **7.30** David Attenborough's Galapagos. **8.25** George Clarke's Amazing Spaces. **9.10** Restoration Australia. **10.10** Catalyst. **11.10** Adam Hills: The Last Leg. **11.50** Penn & Teller: Fool Us. **12.35am** The Making Of David Attenborough's Galapagos. **1.25** ABC News Update. **1.30** Close. **5.00** Clangers. **5.20** Sarah & Duck. **5.30** Guess How Much I Love You. **5.40** Late Programs.

**NITV (34)** **6am** Morning Programs. **1.30pm** Elements. **2.00** Shortland St. **2.30** Red Chef Revival. **3.00** Jarjums. **4.00** Aussie Bush Tales. **4.10** Grace Beside Me. **4.35** Spartakus And The Sun Beneath The Sea. **5.00** Our Stories. **5.30** APTN National News. **6.00** Bamay. **6.40** News. **6.50** Unknown Amazon. **7.40** Through The Wormhole With Morgan Freeman. **8.30** Living Black. **9.00** I, Sniper. **10.00** Atlanta. **10.40** Late Programs.

## SBS (3)

**6.00** WorldWatch. **9.10** Home Is Where The Art Is. (PG) **10.00** Employable Me (USA) (Ma) **10.50** Icons. (Final, PG) **11.45** Bamay. (R) **12.10** WorldWatch. **2.00** Cook Up With Adam Liaw Bitesize. (R) **2.05** The Windsors' Lost Letters. (PGad, R) **3.00** Going Places. (R) **3.45** The Cook Up. (PG, R) **4.15** The Wonderful World Of Chocolate. (R) **5.05** Jeopardy! (PG) **5.30** Letters And Numbers. (R)

**6.00** The Cook Up With Adam Liaw. (PG) **6.30** SBS World News. **7.30** Saving Lives At Sea. (M) **8.30** DNA Family Secrets. (Return, PG) Presented by Stacey Dooley. **9.40** 24 Hours In Emergency: Into The Light. (Ma, R) An 11-year-old is rushed to St George's. **10.35** SBS World News Late. **11.05** Black Sands. (MA15+av) **12.10** Outlander. (Malv, R) **1.10** Miss S. (PGav, R) **4.00** 8 Out Of 10 Cats Does Countdown. (Mals, R) **4.55** Destination Flavour: Singapore Bitesize. (PG, R) **5.00** NHK World English News Morning. **5.30** ANC Philippines The World Tonight.

**SBS VICELAND (31)** **6am** WorldWatch. **8.40** Abandoned. **9.30** Shortland St. **11.00** Beerland. **Noon** Border To Border. **12.30** Marry Me, Marry My Family. **1.30** Donkmaster. **2.00** Black Lives Matter: A Global Reckoning. **2.55** Dead Set On Life. **3.55** WorldWatch. **5.15** Shortland St. **5.45** Joy Of Painting. **6.15** Forged In Fire. **7.05** Jeopardy! **7.35** 8 Out Of 10 Cats. **8.30** Dark Side Of The '90s. (Return) **9.25** PEN15. **10.25** Late Programs.

**SBS WORLD MOVIES (32)** **6am** Buggy Malone. Continued. (1976, PG) **6.25** Sometimes Always Never. (2018, PG) **8.05** Pixies. (2015, PG) **9.30** Long Way North. (2015, PG) **11.00** Tanu Weds Manu Returns. (2015, PG, Hindi) **1.20pm** Yeh Jawaani Hai Deewani. (2013, PG) **4.15** Devdas. (2002, PG, Hindi) **7.50** Kill Switch. (2017, M) **9.30** Children Of Men. (2006, MA15+) **11.30** Late Programs.

## SEVEN (6)

**6.00** Sunrise. **9.00** The Morning Show. (PG) **11.30** Seven Morning News. **12.00** To Be Advised. **1.30** Surveillance Oz. (PG, R) **2.00** Criminal Confessions: A Killer App. (Mav, R) **3.00** The Chase. **4.00** Seven News At 4. **5.00** The Chase Australia.

**6.00** Seven News. **7.00** Home And Away. (PG) **7.30** My Kitchen Rules. (Pgl) Hosted by Manu Feildel and Nigella Lawson. **9.10** 9-1-1: Lone Star. (Mav) The 126 races to emergencies at a fast-food drive-through, a wrestling match and a case of road rage. **10.10** S.W.A.T. (Return, Mav) The team pursues El Diablo's drug cartel. **11.10** The Latest: Seven News. **11.40** Heartbreak Island Australia. (Premiere, Mls) **12.50** MOVIE: Until We Are Safe. (2016, MA15+av) Beth Grant. **3.00** Home Shopping. (R) **4.00** NBC Today. **5.00** Seven Early News. **5.30** Sunrise.

**7MATE (60)** **6am** Morning Programs. **9.00** NFL 100 Greatest. **10.00** Jabba's Movies. **10.30** Storage Wars. **11.00** American Pickers. **Noon** Demolition NZ. **1.00** Crazy On A Plane. **2.00** Big Easy Motors. **2.30** Leepu And Pitbull. **3.30** Rides Down Under: Workshop Wars. **4.30** Aussie Lobster Men. **5.30** Storage Wars. **6.00** American Pickers. **7.00** Pawn Stars. **7.30** Full Custom Garage. **8.30** MOVIE: Die Hard. (1988, M) **11.15** Late Programs.

**7TWO (62)** **6am** Morning Programs. **8.00** Harry's Practice. **8.30** Million Dollar Minute. **9.30** NBC Today. **10.30** To Be Advised. **Noon** Crazy On A Plane. **1.00** Million Dollar Minute. **2.00** Weekender. **2.30** Sons And Daughters. **4.30** Emmertale. **5.00** Coronation Street. **5.30** Escape To The Country. **6.30** Bargain Hunt. (Return) **7.30** Doc Martin. **8.30** A Touch Of Frost. **10.15** Criminal Confessions. **11.15** Late Programs.

## NINE (8)

**6.00** Today. **9.00** Today Extra. (PG) **11.30** Morning News. **12.00** The Block. (Pgl, R) **1.30** Getaway. (PG, R) **2.00** Pointless. (PG) **3.00** Tipping Point. (PG) **4.00** Millionaire Hot Seat. **5.00** Afternoon News.

**6.00** Nine News. **7.00** A Current Affair. **7.30** The Block. (Pgl) Hosted by Scott Cam. **8.45** Emergency. (Mlm) A truck accident victim needs two tourniquets above the knee to stop severe blood loss. **9.45** Footy Classified. (M) Footy experts tackle the AFL's big issues. **10.45** Nine News Late. **11.15** Manifest. (Mav) **12.05** Emergence. (Mhv, R) **1.00** Hello SA. (PG, R) **1.30** TV Shop: Home Shopping. (R) **2.30** Global Shop. (R) **3.00** TV Shop: Home Shopping. (R) **4.00** Believer's Voice Of Victory. (PGa) **4.30** A Current Affair. (R) **5.00** News Early Edition. **5.30** Today.

**9GEM (81)** **6am** TV Shop. **7.00** Creflo. **7.30** TV Shop. **9.30** Newstyle Direct. **10.00** Danoz. **10.30** Pointless. **11.30** My Favorite Martian. **Noon** Days Of Our Lives. **12.55** The Young And The Restless. **1.50** The Bill. **2.50** Antiques Roadshow. **3.20** MOVIE: The Dove. (1974) **5.30** Murder, She Wrote. **6.30** Antiques Roadshow. **7.30** Death In Paradise. **8.40** MOVIE: Agatha And The Midnight Murders. (2020, M) **10.40** Late Programs.

**9GO! (82)** **6am** Children's Programs. **Noon** The Bionic Woman. **1.00** Buck Rogers. **2.00** Motor Racing. Formula E C'ship. Seoul ePrix. H'lights. **3.00** Full House. **3.30** Raymond. **5.30** The Nanny. **6.00** 3rd Rock. **6.30** That '70s Show. **7.00** Young Sheldon. **7.30** RBT. **8.30** MOVIE: Blade: Trinity. (2004, MA15+) **10.45** Young Sheldon. **11.10** Up All Night. **11.40** Raymond. **12.10am** 90 Day Fiance. **2.00** Snapped. **2.50** Late Programs.

## TEN (5)

**6.00** Ent. Tonight. (R) **6.30** GCBC. (R) **7.00** Judge Judy. (PG, R) **7.30** Bold. (R) **8.00** 10 News First: Breakfast. **8.30** Studio 10. (PG) **12.00** Dr Phil. (PGad) **1.00** To Be Advised. **2.00** Entertainment Tonight. **2.30** Farm To Fork. (PG, R) **3.00** Judge Judy. (PG, R) **3.30** My Market Kitchen. **4.00** Everyday Gourmet With Justine Schofield. **4.30** The Bold And The Beautiful. (PGa) **5.00** 10 News First.

**6.30** The Project. A look at the day's news and events. **7.30** The Masked Singer Australia. Hosted by Osher Günsberg. **8.40** Have You Been Paying Attention? (Malns) Celebrity panellists compete to see who can remember the most about events of the week. **9.40** Just For Laughs Australia. (MA15+) Hosted by Nath Valvo. **10.10** The Montreal Comedy Festival. (MA15+, R) Stand-up performances from comedians. **11.10** The Project. (R) **12.10** The Late Show With Stephen Colbert. (PG) **1.00** Home Shopping. (R) **4.30** CBS Mornings.

**10 BOLD (51)** **6am** Home Shopping. **8.00** The Doctors. **9.00** Escape Fishing With ET. **9.30** iFish. **10.00** Tough Tested. **11.00** MacGyver. **Noon** NCIS: New Orleans. **1.00** Walker, Texas Ranger. **3.00** Bondi Rescue. **3.30** The Love Boat. **4.30** Star Trek: The Next Generation. **5.30** MacGyver. **7.30** NCIS. **10.20** Blue Bloods. **12.15am** Home Shopping. **2.15** L.A.'s Finest. **3.10** MacGyver. **5.00** The Doctors.

**10 PEACH (52)** **6am** Friends. **7.00** The Big Bang Theory. **10.00** The Middle. **Noon** The Big Bang Theory. **1.00** Charmed. **2.00** The Big Bang Theory. **3.00** The King Of Queens. **4.00** Becker. **5.00** Frasier. **6.00** Friends. **8.00** The Big Bang Theory. **9.30** Seinfeld. **11.00** Frasier. **Midnight** Home Shopping. **1.30** The Late Show With Stephen Colbert. **2.30** The Late Show With James Corden. **3.30** The King Of Queens. **4.30** Shopping.



ABC TV (2)

6.00 News Breakfast. 9.00 ABC News Mornings. 10.00 Foreign Correspondent. (R) 10.30 China Tonight. (R) 11.00 Joanna Lumley's Britain. (PG, R) 12.00 ABC News At Noon. 1.00 Miniseries: The War Of The Worlds. (Mv, R) 1.55 The Durrells. (PG, R) 3.00 Escape From The City. (R) 4.00 Think Tank. (R) 5.00 Anh's Brush With Fame. (PG, R) 5.25 Hard Quiz. (PG, R)

6.00 The Drum. 7.00 ABC News. 7.30 7.30. Presented by Sarah Ferguson. 8.00 Great Southern Landscapes. (PG) Rachel Griffiths heads to Melbourne. 8.30 Australia's Favourite Tree. Part 1 of 2. Dr Ann Jones and Paul West travel across Australia to learn about the lives of iconic trees. 9.30 Science Of Drugs With Richard Roxburgh: Legal And Lethal. (Mad) Part 1 of 4. 10.30 ABC Late News. 10.45 The Business. (R) 11.00 Four Corners. (R) 11.45 Media Watch. (PG, R) 12.00 The Capture. (Mlv, R) 1.00 Wakefield. (Mls, R) 2.00 The Durrells. (PG, R) 2.50 Rage. (MA15+adhlsv) 4.25 The Drum. (R) 5.25 7.30. (R)

ABC TV PLUS (22) 6am Children's Programs. 7.15pm Obki. 7.20 Bluey. 7.30 Spicks And Specks. 8.00 Would I Lie To You? 8.30 Adam Hills: The Last Leg. 9.10 Friday Night Dinner. 9.35 Rosehaven. 10.05 Aftertaste. 10.35 Black Books. (Final) 11.00 Whose Line Is It Anyway? 11.25 Brassic. 12.10am The Stand Up Sketch Show. 12.30 Mock The Week. 1.05 ABC News Update. 1.10 Close. 5.00 Clangers. 5.20 Sarah & Duck. 5.30 Late Programs.

NITV (34) 6am Morning Programs. 2pm Shortland St. 2.30 Red Chef Revival. 3.00 Jarjums. 4.35 Spartakus And The Sun Beneath The Sea. 5.00 Our Stories. 5.30 Indian Country Today News. 6.00 Bamay. 6.30 News. 6.40 Unknown Amazon. 7.30 Colonial Combat. 8.00 Spirit Talker. 8.30 Over The Black Dot. 9.00 Feeding The Scrum. 9.30 Letterkenny. 10.00 The Crimson Rivers. 10.55 Late Programs.

SBS (3)

6.00 WorldWatch. 9.00 Cook Up With Adam Liaw Bitesize. (R) 9.15 Home Is Where The Art Is. (PG) 10.10 Employable Me (USA) (Ma) 11.00 Secret Cities. (PG) 12.00 WorldWatch. 2.05 The Windsors' Lost Letters. (PGdl, R) 3.00 Living Black. (R) 3.40 The Cook Up. (PG, R) 4.10 The Wonderful World Of Chocolate. (R) 5.05 Jeopardy! (PG) 5.30 Letters And Numbers. (R)

6.00 The Cook Up With Adam Liaw. (PG) 6.30 SBS World News. 7.30 Great Coastal Railway Journeys: Dunbar To Edinburgh. (Premiere, PG) Hosted by Michael Portillo. 8.30 Insight. Kumi Taguchi takes a look back at Australia's involvement in the war in Afghanistan. 9.30 Dateline: Surviving The Circus. A look inside Nepal's only circus troupe. 10.00 SBS World News Late. 10.30 Australia's Health Revolution. (PGa, R) 11.30 Atlanta. (Madlv, R) 12.45 Before We Die. (MA15+dv, R) 4.00 8 Out Of 10 Cats Does Countdown. (Mals, R) 4.55 Destination Flavour: Singapore Bitesize. (R) 5.00 NHK World English News Morning. 5.30 ANC Philippines The World Tonight.

SBS VICELAND (31) 6am WorldWatch. 8.40 Abandoned. 9.30 Shortland St. 11.00 Beerland. Noon VICE. 1.10 Hustle. 2.00 Chasing Famous. 2.50 Counter Space. 3.50 WorldWatch. 5.15 Shortland St. 5.45 Joy Of Painting. 6.15 Forged In Fire. 7.05 Jeopardy! 7.35 8 Out Of 10 Cats Does Countdown. 8.30 Craig Charles: UFO Conspiracies. 9.25 Cocaine Trade Exposed: The Invisibles. 10.20 Cavendish. 11.10 Das Boot. 12.05am Late Programs.

SBS WORLD MOVIES (32) 6am Long Way North. Continued. (2015, PG) 7.15 Yeh Jawaani Hai Deewani. (2013, PG) 10.10 Canopy. (2013, M) 11.40 Sheep Without A Shepherd. (2019, M, Mandarin) 1.45pm Sometimes Always Never. (2018, PG) 3.25 Tanu Weds Manu Returns. (2015, PG, Hindi) 5.40 Akira Kurosawa's Dreams. (1990, PG, Japanese) 7.55 The One. (2001) 9.30 Sputnik. (2020, MA15+, Russian) 11.35 Late Programs.

SEVEN (6)

6.00 Sunrise. 9.00 The Morning Show. (PG) 11.30 Seven Morning News. 12.00 To Be Advised. 1.40 Surveillance Oz. (PGn, R) 2.00 World's Deadliest: Days Out. (Ml, R) 3.00 The Chase. 4.00 Seven News At 4. 5.00 The Chase Australia.

6.00 Seven News. 7.00 Home And Away. (PG) 7.30 My Kitchen Rules. (PGI) New teams of home cooks set out to impress hosts and judges Manu Feildel and Nigella Lawson. 9.10 Harry Palmer: The Ipcress File. (Mav) Harry and Jean's relationship intensifies when he chases Randall to Beirut, where he holds Dawson. 11.30 The Latest: Seven News. 12.00 Celebrity Obsessed: John Lennon. (Mav, R) Examines the case of Mark David Chapman. 1.00 Hooked On The Look. (Ma, R) 1.30 Travel Oz. (PG, R) 2.00 Home Shopping. (R) 4.00 NBC Today. 5.00 Seven Early News. 5.30 Sunrise.

7MATE (60) 6am Morning Programs. 10.00 Storage Wars. 10.30 Pawn Stars. 11.00 American Pickers. Noon Demolition NZ. 1.00 Crazy On A Plane. 2.00 Full Custom Garage. 3.00 Shipping Wars. 3.30 Pawn Stars UK. 4.00 Pawn Stars Sth Africa. 4.30 Aussie Lobster Men. 5.30 Storage Wars. 6.00 American Pickers. 7.00 Pawn Stars. 7.30 Highway Patrol. 8.30 Outback Opal Hunters. 10.30 Jade Fever. 11.00 Late Programs.

7TWO (62) 6am Home Shopping. 6.30 Travel Oz. 8.00 Harry's Practice. 8.30 Million Dollar Minute. 9.30 NBC Today. Noon Crazy On A Plane. 1.00 Million Dollar Minute. 2.00 Creek To Coast. 2.30 Sons And Daughters. 4.30 Emmerdale. 5.00 Coronation Street. 5.30 Escape To The Country. 6.30 Bargain Hunt. 7.30 Rosemary & Thyme. 8.30 Judge John Deed. 10.30 Wild Bill. 11.30 Late Programs.

NINE (8)

6.00 Today. 9.00 Today Extra. (PG) 11.30 Morning News. 12.00 The Block. (Pgl, R) 1.00 Emergency. (Mlm, R) 2.00 Pointless. (PG) 3.00 Tipping Point. (PG) 4.00 Millionaire Hot Seat. 5.00 Afternoon News.

6.00 Nine News. 7.00 A Current Affair. 7.30 The Block. (Pgl) Hosted by Scott Cam. 8.40 The Hundred With Andy Lee. Andy Lee is joined by a panel of comedians and 100 Aussies to explore the fun behind the facts. 9.40 My Feet Are Killing Me. (Mm) Vincent fixes a woman's foot. 10.40 Nine News Late. 11.10 Law & Order: Organized Crime. (MA15+av) 12.00 Game Of Silence. (Mav) 12.50 Destination WA. (PG, R) 1.20 Talking Honey. (PG) 1.30 TV Shop: Home Shopping. (R) 4.00 Believer's Voice Of Victory. (PGa) 4.30 A Current Affair. (R) 5.00 News Early Edition. 5.30 Today.

9GEM (81) 6am TV Shop. 7.00 Creflo. 7.30 TV Shop. 9.30 Newstyle Direct. 10.00 Danoz. 10.30 Pointless. 11.30 My Favorite Martian. Noon Days Of Our Lives. 12.55 The Young And The Restless. 1.50 The Bill. 2.50 Antiques Roadshow. 3.20 MOVIE: S'P'Y'S. (1974, PG) 5.30 Murder, She Wrote. 6.30 Antiques Roadshow. 7.30 New Tricks. 8.40 The Closer. 9.40 Rizzoli & Isles. 10.40 Law & Order: S.V.U. 11.40 Late Programs.

9GO! (82) 6am Children's Programs. Noon The Bionic Woman. 1.00 Buck Rogers. 2.00 Motor Racing. Formula E C'ship. Seoul ePrix. H'lights. 3.00 The Nanny. 3.30 3rd Rock. 4.00 That '70s Show. 4.30 Raymond. 5.30 The Nanny. 6.00 3rd Rock. 6.30 That '70s Show. 7.00 Young Sheldon. 7.30 MOVIE: The Hunt For Red October. (1990, PG) 10.15 MOVIE: RoboCop. (1987, MA15+) 12.15am Late Programs.

TEN (5)

6.00 Ent. Tonight. (R) 6.30 GCBC. (R) 7.00 Judge Judy. (PG, R) 7.30 Bold. (PGa, R) 8.00 10 News First: Breakfast. 8.30 Studio 10. (PG) 12.00 Dr Phil. (Mav) 1.00 To Be Advised. 2.00 Entertainment Tonight. 2.30 Farm To Fork. (PG, R) 3.00 Judge Judy. (PG, R) 3.30 My Market Kitchen. 4.00 Everyday Gourmet With Justine Schofield. 4.30 The Bold And The Beautiful. 5.00 10 News First.

6.30 The Project. A look at the day's news and events. 7.30 The Masked Singer Australia. Hosted by Osher Günsberg. 8.30 The Cheap Seats. (Mal) From major news stories to entertainment and viral videos, presenters Melanie Bracewell and Tim McDonald take a look at the week that was. 9.30 NCIS. (Mv, R) Jessica Knight joins the team to help investigate an explosion that killed a NCIS training team. 10.30 NCIS: Los Angeles. (Mav, R) Callen discovers who accused him of being a spy. 11.30 The Project. (R) 12.30 The Late Show With Stephen Colbert. (PG) 1.30 Home Shopping. (R) 4.30 CBS Mornings.

10 BOLD (51) 6am Home Shopping. 8.00 The Doctors. 9.00 Escape Fishing With ET. 9.30 iFish. 10.00 MacGyver. Noon NCIS: New Orleans. 1.00 Walker, Texas Ranger. 3.00 Bondi Rescue. 3.30 To Be Advised. 4.30 Star Trek: The Next Generation. 5.30 MacGyver. 7.30 NCIS. 8.30 Bull. 10.20 48 Hours. 12.15am Home Shopping. 2.15 MOVIE: Deep Rising. (1998, MA15+) 4.20 iFish. 4.30 Reel Action. 5.00 The Doctors.

10 PEACH (52) 6am The Late Show With Stephen Colbert. 7.00 The King Of Queens. 8.00 Seinfeld. 9.30 Becker. 10.30 The Middle. 11.00 Frasier. Noon The Big Bang Theory. 1.30 Seinfeld. 3.00 The King Of Queens. 4.00 Becker. 5.00 Frasier. 6.00 Friends. 8.00 The Big Bang Theory. 9.30 Mom. 11.10 Frasier. Midnight Shopping. 1.30 Stephen Colbert. 2.30 James Corden. 3.30 King Of Queens. 4.30 Shopping.



# Trouble Sleeping?

**Got Back Pain? Neck Pain? Can't Get A Good Night's Sleep?**

- Relaxing Vibrating Massage
- Fully Adjustable Height
- Split Bed Options

Call Now! 1800 440 440

Free Gifts Worth \$600.00



\*Call for Terms & Conditions

Wednesday, August 17

ABC TV (2)

6.00 News Breakfast. 9.00 ABC News Mornings. 10.00 Four Corners. (R) 11.00 Singapore's Secret Forests With David Attenborough. (R) 12.00 ABC News At Noon. 12.30 National Press Club Address. 1.40 Media Watch. (PG, R) 2.00 The Durrells. (PG, R) 3.00 Escape From The City. (R) 4.00 Think Tank. (R) 4.55 Anh's Brush With Fame. (PG, R) 5.25 Hard Quiz. (PG, R)

6.00 The Drum. 7.00 ABC News. 7.30 7.30. 8.00 Win The Week. (PG) Hosted by Alex Lee. 8.30 Shaun Micallef's MAD AS HELL. (M) Hosted by Shaun Micallef. 9.00 Aftertaste. (Ml) Diana's menu causes issues for Harry. 9.30 Adam Hills: The Last Leg. (R) UK-based panel show. 10.15 ABC Late News. 10.30 The Business. (R) 10.45 Spicks And Specks. (PG, R) 11.35 Midsomer Murders. (Mv, R) 1.05 Wakefield. (MA15+, R) 2.05 The Durrells. (PG, R) 2.55 Rage. (MA15+adhlsv) 4.25 The Drum. (R) 5.25 7.30. (R)

ABC TV PLUS (22) 6am Children's Programs. 7.15pm Obki. 7.20 Bluey. 7.30 Anh's Brush With Fame. 8.00 Art Works. 8.30 Civilisations. 9.30 Great Southern Landscapes. 10.00 Talking Heads. 10.40 Everyone's A Critic. (Final) 11.05 Louis Theroux: Miami Mega Jail. 12.05am Catalyst. 1.05 ABC News Update. 1.10 Close. 5.00 Clangers. 5.15 Hoot Hoot Go! 5.20 Sarah & Duck. 5.30 Late Programs.

NITV (34) 6am Morning Programs. 1.30pm Artie: Our Tribute To A Legend. 2.00 Shortland St. 2.30 Red Chef Revival. 3.00 Jarjums. 4.35 Spartakus And The Sun Beneath The Sea. 5.00 Our Stories. 5.30 Te Ao With Moana. 6.00 Bamay. 6.30 News. 6.40 Unknown Amazon. 7.30 The Last Land: Gespe'gewagi. 8.30 Yokoyi Footy. 9.25 Bruce Lee: Martial Arts Master. 10.25 Always Was Always Will Be. 11.00 Late Programs.

SBS (3)

6.00 WorldWatch. 9.00 Cook Up With Adam Liaw Bitesize. (R) 9.20 Home Is Where The Art Is. (PG) 10.10 Employable Me (USA) (Ma) 11.00 Soccer. FIFA U-20 Women's World Cup. Match 18. Australia v Spain. 1.30 WorldWatch. 2.00 Dateline. (R) 2.30 Insight. (R) 3.40 The Cook Up. (PG, R) 4.10 The Wonderful World Of Chocolate. (R) 5.05 Jeopardy! (PG) 5.30 Letters And Numbers. (R)

6.00 The Cook Up With Adam Liaw. (PG) 6.30 SBS World News. 7.35 Tony Robinson's History Of Britain: Romans. (PGa, R) Part 1 of 4. 8.30 Secret Scotland: Fife And The East. (R) Susan Calman pays a visit to Falkland Palace, once the secret retreat of Scottish royalty. 9.25 The Stranger. (Premiere, MA15+) A man's life is thrown into chaos. 10.25 SBS World News Late. 10.55 Vienna Blood. (MA15+a) 12.35 Agent Hamilton. (Malv, R) 4.50 Destination Flavour: Singapore Bitesize. (R) 5.00 NHK World English News Morning. 5.30 ANC Philippines The World Tonight.

SBS VICELAND (31) 6am WorldWatch. 8.40 Abandoned. 9.30 Shortland St. 11.00 Beerland. Noon The Source. 1.50 In My Own World. 2.45 It's Supper! 3.45 WorldWatch. 5.15 Shortland St. 5.45 Joy Of Painting. 6.15 Forged In Fire. 7.05 Jeopardy! 7.35 8 Out Of 10 Cats Does Countdown. 8.30 Celebrity Letters And Numbers. 9.35 Glastonbury Festival. (Premiere) 11.50 Late Programs.

SBS WORLD MOVIES (32) 6am Pixies. Continued. (2015, PG) 6.35 Devdas. (2002, PG, Hindi) 10.10 Nebraska. (2013, M) 12.15pm Night Of The Undead. (2020, M, Korean) 2.20 Asterix And Obelix In Britain. (2012, PG, French) 4.25 The Crow's Egg. (2014, PG, Tamil) 6.05 Jetsons: The Movie. (1990) 7.35 Mars Attacks! (1996) 9.30 The Fifth Element. (1997, PG) 11.50 How To Talk To Girls At Parties. (2017, MA15+) 1.45am Late Programs.

SEVEN (6)

6.00 Sunrise. 9.00 The Morning Show. (PG) 11.30 Seven Morning News. 12.00 To Be Advised. 1.40 Surveillance Oz. (PG, R) 2.00 World's Deadliest: Bail Outs. (PGa, R) 3.00 The Chase. (R) 4.00 Seven News At 4. 5.00 The Chase Australia.

6.00 Seven News. 7.00 Home And Away. (PGav) 7.30 Dogs Behaving (Very) Badly. (PG) Presented by Graeme Hall. 8.30 Martin Clunes: Islands Of The Pacific: South West Pacific. (PGa) Part 2 of 3. Martin Clunes climbs a volcano in Vanuatu and meets a tribe who worships Prince Philip. 9.40 Air Crash Investigation: Playing Catch Up. (PG) A look at the crash of Execufly Flight 1526. 10.40 The Latest: Seven News. 11.10 Chicago Fire. (Ma) 12.10 Reckoning. (MA15+a, R) 1.10 Travel Oz. (PG, R) 2.00 Home Shopping. (R) 4.00 NBC Today. 5.00 Seven Early News. 5.30 Sunrise.

7MATE (60) 6am Morning Programs. 10.00 Storage Wars. 10.30 Pawn Stars. 11.00 American Pickers. Noon Demolition NZ. 1.00 Crazy On A Plane. 2.00 Jade Fever. 3.00 Shipping Wars. 3.30 Pawn Stars UK. 4.00 Pawn Stars Sth Africa. 4.30 Aussie Lobster Men. 5.30 Storage Wars. 6.00 American Pickers. 7.00 Pawn Stars. 7.30 Family Guy. 8.00 American Dad! 8.30 MOVIE: Batman Begins. (2005, M) 11.20 Late Programs.

7TWO (62) 6am Home Shopping. 6.30 Travel Oz. 8.00 Harry's Practice. 8.30 Million Dollar Minute. 9.30 NBC Today. Noon Escape To The Country. 1.00 Million Dollar Minute. 2.00 RSPCA Animal Rescue. 2.30 Sons And Daughters. 4.30 Emmerdale. 5.00 Coronation Street. 5.30 Escape To The Country. 6.30 Bargain Hunt. 7.30 Heartbeat. 8.30 Lewis. 10.30 Miniseries: Bancroft. 11.30 Late Programs.

NINE (8)

6.00 Today. 9.00 Today Extra. (PG) 11.30 Morning News. 12.00 The Block. (Pgl, R) 1.00 The Hundred With Andy Lee. (R) 2.00 Pointless. (PG) 3.00 Tipping Point. (PG) 4.00 Millionaire Hot Seat. 5.00 Afternoon News.

6.00 Nine News. 7.00 A Current Affair. 7.30 The Block. (Pgl) Hosted by Scott Cam. 8.30 After The Verdict. (Mlv) Clara sees accused killer Heidi in a new light when they both find themselves the target of a stalker. 9.30 Family Law. (Mas) A couple ask Abigail for help. 10.30 Footy Classified. (M) 11.25 Nine News Late. 11.50 Chicago Med. (MA15+am, R) 12.45 Everything Outdoors. 1.15 Garden Gurus Moments. (R) 1.30 TV Shop: Home Shopping. (R) 2.30 Global Shop. (R) 3.00 TV Shop: Home Shopping. (R) 4.00 Believer's Voice Of Victory. (PGa) 4.30 A Current Affair. (R) 5.00 News Early Edition. 5.30 Today.

9GEM (81) 6am TV Shop. 7.00 Creflo Dollar Ministries. 7.30 TV Shop: Home Shopping. 10.30 Pointless. 11.30 My Favorite Martian. Noon Days Of Our Lives. 12.55 The Young And The Restless. 1.50 New Tricks. 3.00 Explore. 3.10 Antiques Roadshow. 3.40 MOVIE: Hell Is A City. (1960, PG) 5.30 Murder, She Wrote. 6.30 Antiques Roadshow. 7.30 As Time Goes By. 8.50 Midsomer Murders. 10.50 Chicago Fire. 11.50 Late Programs.

9GO! (82) 6am Children's Programs. Noon The Bionic Woman. 1.00 Buck Rogers. 2.00 Baywatch. 3.00 The Nanny. 3.30 3rd Rock. 4.00 That '70s Show. 4.30 Raymond. 5.30 The Nanny. 6.00 3rd Rock. 6.30 That '70s Show. 7.00 Young Sheldon. 7.30 MOVIE: The Space Between Us. (2017, M) 9.50 MOVIE: Fargo. (1996, MA15+) 11.50 Young Sheldon. 12.15am 90 Day Fiance. 2.10 Snapped. 3.00 Late Programs.

TEN (5)

6.00 Ent. Tonight. (R) 6.30 GCBC. (R) 7.00 Judge Judy. (PG, R) 7.30 Bold. (R) 8.00 10 News First: Breakfast. 8.30 Studio 10. (PG) 12.00 Dr Phil. (Mal) 1.00 To Be Advised. 2.00 Entertainment Tonight. 2.30 Farm To Fork. (PG, R) 3.00 Judge Judy. (PG, R) 3.30 My Market Kitchen. 4.00 Everyday Gourmet With Justine Schofield. 4.30 The Bold And The Beautiful. 5.00 10 News First.

6.30 The Project. A look at the day's news and events. 7.30 Shaun Micallef's Brain Eisteddfod. Quiz show featuring schools. 8.30 Ghosts. (Pga) Alberta is thrilled when a super-fan of her music visits the mansion to learn more about her. 9.30 Bull. (Ma, R) Benny represents the plaintiff and Chunk represents the defendant in the same civil suit. 10.30 Good Sam. (Ma) Griff awaits the results of his MRI. 11.30 The Project. (R) 12.30 The Late Show With Stephen Colbert. (PG) 1.30 Home Shopping. (R) 4.30 CBS Mornings.

10 BOLD (51) 6am Home Shopping. 8.00 The Doctors. 9.00 Escape Fishing With ET. 9.30 iFish. 10.00 MacGyver. Noon NCIS: New Orleans. 1.00 Walker, Texas Ranger. 3.00 Bondi Rescue. 3.30 The Love Boat. 4.30 Star Trek: The Next Generation. 5.30 MacGyver. 7.30 NCIS. 8.30 Hawaii Five-0. 10.20 Blood And Treasure. 11.15 Evil. 12.15am Home Shopping. 2.15 Hawaii Five-0. 3.10 MacGyver. 5.00 The Doctors.

10 PEACH (52) 6am The Late Show With Stephen Colbert. 7.00 Friends. 8.00 The King Of Queens. 9.00 Becker. 10.00 The Middle. 11.00 The Big Bang Theory. Noon Friends. 1.00 Frasier. 2.00 Becker. 3.00 The King Of Queens. 4.00 Becker. 5.00 Frasier. 6.00 Friends. 8.00 The Big Bang Theory. 11.00 Frasier. Midnight Shopping. 1.30 Stephen Colbert. 2.30 James Corden. 3.30 King Of Queens. 4.30 Shopping.



## GIANT CROSSWORD

No. 057

### ACROSS

- 1 Derision (7)
- 5 Scales (7)
- 9 Blade affixed to firearm (7)
- 15 Thrift (7)
- 17 Jumped (5)
- 19 Result (7)
- 20 Oily fruit (5)
- 21 Hear (5)
- 22 Tried hard, struggled (7)
- 23 Annoy (5)
- 24 Sports person, e.g. Simone Biles (7)
- 25 Conceal (4)
- 26 Shrimp (4)
- 27 Partially or wholly coincide (7)
- 29 White ant (7)
- 30 Needle case (4)
- 32 Flightless bird of South America (4)
- 33 Approval (6)
- 35 Salt or ester (7)
- 38 Soft colour (6)
- 41 Fastened a knot (4)
- 42 The Earth has two (4)
- 44 Consulate (7)
- 46 More intelligent (7)
- 48 Meeting (11)
- 50 Tip off, give notice (8)
- 51 Foe (8)
- 52 Hazardously (11)
- 55 Eagerly but wrongfully desired (7)
- 57 Engulfs (7)
- 58 Australian salt lake (4)
- 59 Indonesian holiday isle (4)
- 60 Ability to see (6)
- 63 Team sport, usually women's or mixed (7)
- 65 Shut (6)
- 69 Use a sieve (4)
- 71 Luxury (4)
- 74 Honeybun (7)
- 77 Refuse (7)

- 78 Operatic melody (4)
- 79 Absent (4)
- 80 Petty (7)
- 82 Perch (5)
- 83 State government leader (7)
- 84 Smell (5)
- 85 Likeness (5)
- 86 Substance used to close or fasten objects (7)
- 87 Playground equipment (5)
- 88 Small country house (7)
- 89 Resisting openly (7)
- 90 Sparkle (7)
- 91 Breathed in (7)

### DOWN

- 2 Having no smell (9)
- 3 Famous Tennessee city (9)
- 4 Artificial silk (5)
- 6 Maintained (7)
- 7 Variety of gypsum (9)
- 8 Tableware implements (7)
- 10 Between (5)
- 11 Tricks (9)
- 12 Calling forth (9)
- 13 Edginess (7)
- 14 Expose to the elements (7)
- 16 Environment (6)
- 18 Throw or hurl (6)
- 28 Trifling (5)
- 29 Records (5)
- 31 Self-reliant (11)
- 32 Able to be quelled (11)
- 34 Brazen (9)
- 36 Hack (4)
- 37 Aid, encourage (4)
- 39 Arbitrary or despotic (9)
- 40 Ideal (7)
- 43 Express objection (7)
- 45 Gap (5)
- 47 Tree (5)
- 48 Additionally (3)
- 49 Plaything (3)
- 53 Way out (4)

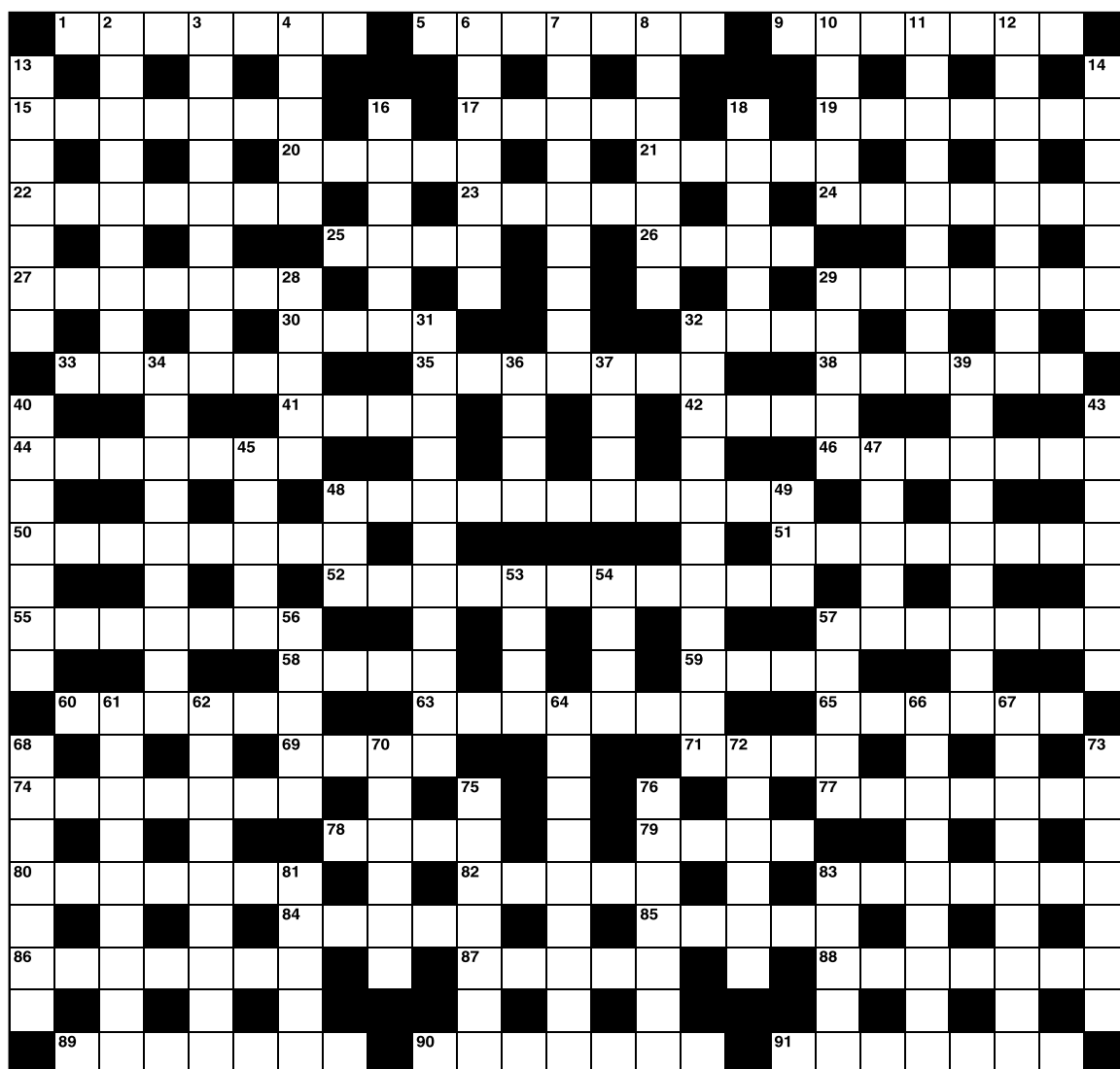

- 54 Tall plant cultivated for its edible pods (4)
- 56 Thick (5)
- 57 Cut into small cubes (5)
- 61 Involve by suggestion (in some matter) (9)
- 62 Fancied (9)
- 64 Student of living organisms (9)
- 66 Group of musicians (9)
- 67 Get rid of entirely (9)
- 68 Rhapsody (7)
- 70 Long, narrow trench (6)
- 72 Personification (6)
- 73 Post-mission interview (7)
- 75 Sunshade (7)
- 76 Exhaustion (7)
- 81 Ancient tongue (5)
- 83 Kind of nut (5)

### ANSWERS:

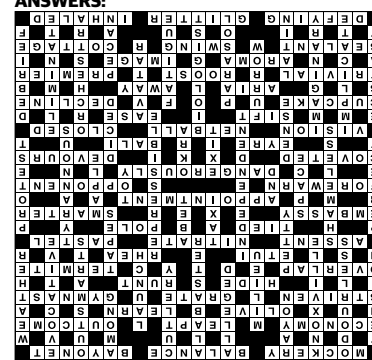

## EDGEWORD

No. 057

pm ORIGINAL PUZZLE

Place each of the tiles of letters into the blank jigsaw below to create four six-letter words going across and down.

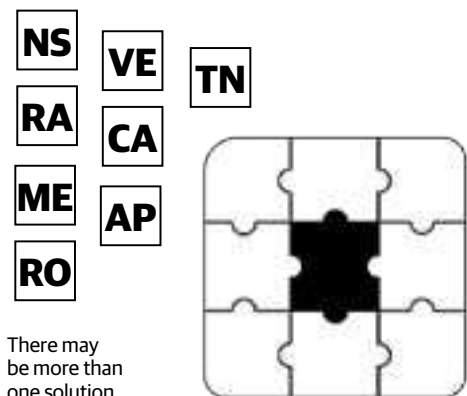

There may be more than one solution

ANSWERS: CATNAP, CAMERA, APRONS, RAVENS

## DROP DOWN

No. 053

Starting with the seven-letter word, drop a letter and form a six-letter word. Continue in this manner until you reach the single letter at the bottom. You can rearrange the letters in each step, if necessary.

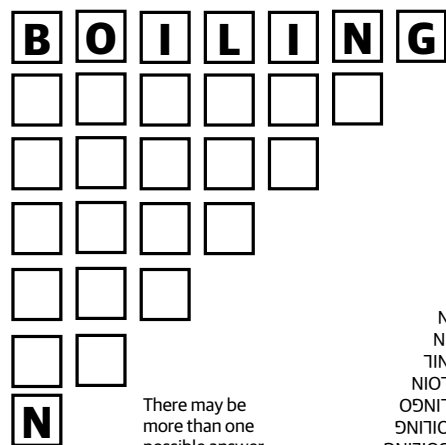

There may be more than one possible answer.

ANSWERS:  
N  
NI  
TIN  
NIOT  
OING  
LING  
BOLING

## HOW WELL DO YOU KNOW...

RUSSELL CROWE

1. Crowe won an Australian Film Institute award for Best Actor in 1992 for his role in which movie?

- A. *The Sum of Us*
- B. *Death in Brunswick*
- C. *Romper Stomper*
- D. *The Boys*

2. Which Australian actor starred alongside Crowe in *LA Confidential*?

- A. Hugh Jackman
- B. Guy Pearce
- C. Heath Ledger
- D. Hugo Weaving

3. His cousins Martin and Jeff Crowe captained New Zealand in which sport?

- A. Hockey
- B. Rugby League
- C. Basketball
- D. Cricket

4. Which actress starred as Crowe's love interest in *A Beautiful Mind*?

- A. Jennifer Connelly
- B. Maggie Gyllenhaal
- C. Kate Winslet
- D. Naomi Watts

5. Which NRL club does he co-own?

- A. Sydney Roosters
- B. Manly Sea Eagles
- C. South Sydney Rabbitohs
- D. Penrith Panthers



ANSWERS: 1C, 2B, 3D, 4A, 5C

## CROSSMATH

No. 057

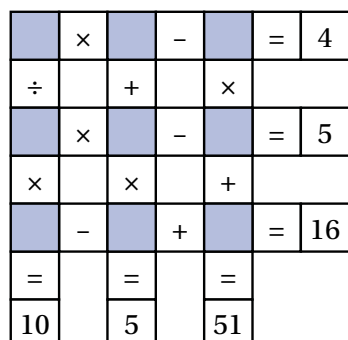

Insert each number from 1 to 9 in the shaded squares to solve all the horizontal and vertical equations.

Multiplication and division are performed before addition and subtraction.

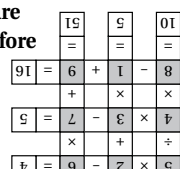

## WORD TRIANGLE

No. 053

The starting letter could be in any segment, and all subsequent letters are able to be connected following a path through the gaps in the walls. You may only enter each of the segments once, and all letters must be used.



HINT: The answer is a phrase.

ANSWER: ON SPEAKING TERMS

## 4x4

No. 053

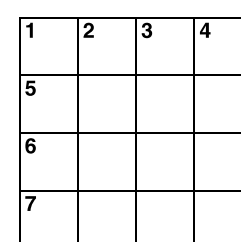

### ACROSS

- 1 Crusted sore (4)
- 5 Burrow (4)
- 6 Press (4)
- 7 Require (4)

### DOWN

- 1 Tibia (4)
- 2 Center (4)
- 3 Emollient (4)
- 4 Curve (4)

ANSWERS: 1. Scab, 5. Hole, 3. Aloe, 4. Bend, 6. Iron, 7. Need, 2. Core, 1. Shin, 2. Core.





# Network Classifieds

sales@networkclassifieds.com.au  
networkclassifieds.com.au

1300 666 808

## Trades & Services

**Asbestos Removal**



LICENSED IN SA AND VIC FOR THE REMOVAL OF FRIABLE AND NON-FRIABLE ASBESTOS sampling | site clean up registers | inspections demolition | reinstatement soil remediation  
08 8733 1454  
admin@southeastasbestos.com.au  
"For the right Advice, Information and Price"

**Computers**



**INK • TONER • PRINTERS  
PAPER • PRINTER SERVICING**

31 Crouch Street South, Mount Gambier  
Ph. 08 8723 6044  
www.cartridgeworld.com.au

**Electricians**



• Solar installer  
• Home Battery Scheme Accredited  
• Domestic & Commercial electrical  
• Pump Sales, Installation & Service  
• Data & telecommunications  
Lic. No. PGE285392  
Locally owned & operated business with 30+ years experience

8 Alexander Square, Millicent SA 5280 Phone 08 8733 4046

**Tiling**



25 Bay Rd, Mount Gambier SA 5290  
(08) 8723 9600  
Monday - Friday: 7:30am - 5pm  
Saturday: 9am - 12pm  
#ichosebeaumonts

## General Notices

**Public Notices and Event**



**DO YOU HAVE SOME SPARE SHED SPACE?**

The Imagine Millicent Arts Group is a voluntary group dedicated to making Millicent Community vibrant through public artworks. IMAG has achieved 7 urban projects, and financial donations are welcome. IMAG is seeking free space of 5 square metres to store its decorated bikes that are used for special events.

If you can assist please phone 0419 840 259

## Announcements

**Deaths**

**CORIGLIANO Frank**  
05/10/1935 - 30/07/2022  
Passed away at home Aged 86 years  
Treasured Husband of Phyllis (dec).  
Adored father and father-in-law to Greg (dec), Kerry, Ned and Kat, Jane and Paul.  
Much loved poppy to Bianca, Jesse (dec), Chloe and Alexander.  
Great Poppy to Leo.  
'Reunited with Mum, Forever In our Hearts'

**Funeral Services**

**CORIGLIANO**  
Family and friends of the late Mr Frank Corigliano are invited to attend his Graveside Funeral Service, being held at the Beachport Cemetery, Admella Drive Beachport on Friday 12th August 2022 commencing at 1pm.

**Wattle Range Funerals**  
17 Short Street, Millicent 08 8733 2067  
www.wattlerangefunerals.com.au

**Funeral Directors**



**WATTLE RANGE FUNERALS**  
The South East's most trusted funeral directors. Caring for the South East since 1935.

Call us on: 08 8733 2067 - Millicent | 08 8762 0099 - Naracoorte  
For funeral details please visit our website:  
wattlerangefunerals.com.au

**Monumental Masons**

**SOUTH EAST MONUMENTS & MEMORIALS**

• Servicing the Limestone Coast  
• Your memorial needs set in stone  
Phone 0428 230 442 or email enquiries@southeastmonuments.com.au

## Employment

**Positions Vacant**

**B DOUBLE DRIVER**

Qube are seeking an experienced B double driver to cart wood chips between forest and yard and port. Candidate will need to have MC licence and will need to live within driving distance or be based in Portland or Mt Gambier for this position.

Contact human.resources@qube.com.au or Chris at 03 5521 1787



## Employment

**Positions Vacant**

I can work in a multi-disciplinary team which helps me to get the best results for my clients. I am part of a supportive and caring team environment, where my colleagues are my best friends. There are many opportunities to diversify my role and continually challenge myself to improve the lives of country people and their families.

**Community Support Worker**  
Day Centre Millicent  
Job Ref: 791634  
www.sahealth.sa.gov.au/careers

**i can**  
...achieve true work life balance in a country community



Government of South Australia  
SA Health

I can work in a multi-disciplinary team which helps me to get the best results for my clients. I am part of a supportive and caring team environment, where my colleagues are my best friends. There are many opportunities to diversify my role and continually challenge myself to improve the lives of country people and their families.

**Community Support Worker - Direct Carer, Casual Pool**  
Limestone Coast Local Health Network  
Country Health Connect  
Mount Gambier, Millicent, Tatiara and Naracoorte  
Multiple Vacancies  
Ref No: 802946  
www.sahealth.sa.gov.au/careers

**i can**  
...achieve true work life balance in a country community



Government of South Australia  
SA Health

**Positions Vacant**

I can utilise my business and management skills in order to contribute to great outcomes in the health system. I can be part of a supportive culture where I can access the very best training and professional development. I enjoy a diverse and varied career path within one organisation, knowing I am making a real and valued contribution.

**Administration Officer**  
Penola War Memorial Hospital  
Penola  
Ref No: 804277  
www.sahealth.sa.gov.au/careers

**i can**  
...be part of a supportive culture that cares about my growth



Government of South Australia  
SA Health

**KUMHO TYRE**  
Better. All-Ways

**SE WHEEL ALIGNMENT & TYRE SERVICE**

**ADMINISTRATION MANAGER**

We are seeking an experienced administration manager to join our dedicated and dynamic team. Preference will be given to applicants with accounting knowledge and experience with MYOB.

**Roles of the position include:**

- Management of debtors and creditors;
- Sales, stock and financial reconciliation;
- Arranging BAS and IAS returns;
- Preparation of financial reports; and
- Fortnightly payroll.

**Accordingly, our ideal applicant will possess the following attributes:**

- Proficient organisation and initiative;
- Excellent written and verbal communication;
- Attention to detail;
- Committed and enthusiastic attitude; and
- Ability to work autonomously and efficiently.

Applications for part-time and full-time employment will be considered. Salary and entitlements will reflect knowledge and experience.

All applications will be held strictly confidential.

To apply, please email a cover letter and resume to admin@sewats.com.au by 5:00pm Friday 19 August 2022.



**Network Classifieds**  
1300 666 808

**ADVERTISE** with us and get **better results** **CALL 1300 666 808**



# Magpies pour on pressure

## Kalangadoo 52 d Robe 41

Kalangadoo had to work hard for its win over Robe in Round 16 of Mid South East netball on Saturday.

Robe hit the court running and through a high level of defensive pressure was able to unsettle Kalangadoo's attack line and force early wayward passes.

Robe goal shooter Sarah Laurie became a focal point in attack and converted strongly.

Towards the end of the quarter Kalangadoo's circle defence of Lauren Kain and Renana Wetherall gained some timely intercepts to peg the margin back to four goals at the first break.

The second quarter was a tight contest, going goal-for-goal, with Ellen Ramke running hard for Robe, feeding goalies Halle Carter and Laurie accurately.

Kalangadoo's Sophie Wrightson and Robe's Lucy Perkins had a tight contest, with Wrightson making Perkins earn every possession but Robe went to the main break with a two goal lead.

The Kalangadoo defenders were able to make a mark on the game during the third quarter, with Wrightson creating turnovers through the mid-court and her efforts were rewarded with some patient netball in attack.

The results saw Kalangadoo take a 35-33 lead to the final break.

During the final quarter Kalangadoo was able to build on the momentum of the third quarter, with goalies Kori Collins and Abbey



Kalangadoo's Jade Peacock moves the ball down the court during the Magpies' hard-fought victory over Robe on Saturday.

Picture: LACHLAN ONIONS

Duncan finding space and converting accurately.

At the other end of the court the defensive pressure made it hard for the Robe goalies to get many opportunities, scoring just eight goals for the quarter.

Kalangadoo finished the game strong to claim an 11-goal victory.

Kain and Wrightson were named best for the Magpies, with Laurie and Maisie Hayes best for Robe.

# Big match milestone: 300 games for Gartner

Mandy Gartner played her 300th game for the Penola Netball Club recently and was the first player to reach the milestone for the club in over 10 years.

Gartner has played the majority of her career in A Grade and A Reserves as a defender.

She has strong defensive instincts and her speed, agility and peripheral vision make her a key player on the defensive end for the Eagles.

Despite being shorter than many of her opponents, her ability to read the play and position herself in the right areas means height is no issue for her.

Gartner is always patient and poised with the ball and her versatility is one of her greatest strengths.

Although she plays primarily as a defender, Gartner often floats through the centre court and has been known to shoot goals when required.

Later in her career, she has been involved in a successful run in B Grade, which included five B grade premierships, with the first in 2010 and the most recent in 2021.

Gartner has regularly stood out for her side and has been runner-up best and fairest on a number of occasions.

In 2015, she won the B Grade Club and League best and fairest awards and was B Grade best and fairest in 2017.

Off the court, Gartner has been heavily committed to the club and coached the 13A side to a premiership in 2014.

She has also been a team manager, um-



Mandy Gartner recently reached the elusive milestone of 300 games for the Penola Netball Club.

pire, uniform coordinator and a member of the committee for numerous years.

Gartner's daughter Taylah, said she was proud to see her mum reach such a significant milestone in her career.

## KOWREE NARACOORTE TATIARA FOOTBALL LEAGUE

A GRADE							RESERVES					UNDER 17s					UNDER 14s																		
<b>NARACOORTE</b>	6.4	11.6	16.8	21.15	(141)		<b>MUNDULLA</b>	8.4	13.9	20.12	25.14	(164)	<b>MUNDULLA</b>	6.1	13.4	15.5	15.5	(95)	<b>NARACOORTE</b>	5.2	10.8	10.8	10.8	(68)											
<b>KINGSTON</b>	2.0	6.1	7.3	8.5	(53)		<b>PADTHAWAY</b>	0.1	0.2	0.3	1.5	(11)	<b>PENOLA</b>	0.2	0.2	0.2	0.2	(2)	<b>KINGSTON</b>	0.0	0.0	0.0	0.0	(0)											
<b>GOALS:</b> Naracoorte: S Willson 7 R Taggart 6 J Steadman 2 S Bates 2 W Walker M Willson B East J Reeves. Kingston: T Lockwood 3 G Cox B Kennedy C Benson T Rogers J Harding							<b>GOALS:</b> Mundulla: W Packer 8 J Edwards 3 R Kuchel 2 L Weatherald 2 S Lewin 2 T Excell 2 L Fryar A Obst H Dowling L Wiese E Staude. Padthaway: Details N/A.					<b>GOALS:</b> Mundulla: L Scown 3 R Dimitriadis 3 E Richards 2 R Croser 2 T Rogers H Keatley N Nankivell Murphy H Davies L Fisher. Penola: Nil.					<b>GOALS:</b> Naracoorte: D Durand 3 C Atkinson 3 N Henderson W Krieger C Scott T Taylor. Kingston: Nil.																		
<b>BEST:</b> Naracoorte: S Willson D Albrecht R Taggart S Bates K Jacobs J Macdonald. Kingston: J Harding B Warner C Wood J Wehl T Lockwood G Cox							<b>BEST:</b> Mundulla: S Lewin W Packer L Weatherald H Dowling L Wiese R Evans. Padthaway: A Stevens R Williams A Orton J Rantall J Grundy A Bryson					<b>BEST:</b> Mundulla: R Croser J Jackson M Pickering H Keatley J Staude E Richards. Penola: T Zerk Z Zema T Currie L Neale J Mccarthy J Henry					<b>BEST:</b> Naracoorte: C Atkinson D Durand H Clark M Lush J Bates. Kingston: T Bastiaans W Ogilvie H Pratt-Parkyn O Clarke B Schmaal K Pope																		
<b>MUNDULLA</b>	3.4	4.8	10.12	13.15	(93)		<b>NARACOORTE</b>	2.3	5.4	11.8	15.12	(102)	<b>NARACOORTE</b>	4.3	12.5	15.8	15.8	(98)	<b>BORDERTOWN</b>	3.5	4.5	6.11	7.12	(54)											
<b>PADTHAWAY</b>	1.2	2.5	3.5	4.9	(33)		<b>KINGSTON</b>	1.0	3.3	3.6	4.6	(30)	<b>KINGSTON</b>	1.1	1.2	1.3	1.3	(9)	<b>KEITH</b>	0.0	3.1	3.1	4.1	(25)											
<b>GOALS:</b> Mundulla: H Kuchel 5 D Mosey B Redden N Mosey J Grosser H Hollams W Nankivell D Burgess D King. Padthaway: T Cox 2 D Broad D Boyanton							<b>GOALS:</b> Naracoorte: J Koennecke 3 F Day 2 T Lawrie L Brunt N Boon C Mackinnon J Sellars R Fergusson H Bennier. Kingston: T Mills 2 G Brice-Marwood B Peterson					<b>GOALS:</b> Naracoorte: M Maney 9 Z Boston 2 T Anderson B Johnson R McMullan J Steadman. Kingston: Details N/A.					<b>GOALS:</b> Bordertown: D Twigden 2 K Neale C Orrock B Pilgrin J Will C Jolly. Keith: H Ross H O'loughlin L Hedges N Harper																		
<b>BEST:</b> Mundulla: H Kuchel N Mosey D Mosey T Wagenknecht J Grosser T Gaden. Padthaway: J Miller W Rivers W Brown T Edwards C Marshall T Cooper							<b>BEST:</b> Naracoorte: J Koennecke N Boon J Sellars C Mackinnon L Brunt R Fergusson. Kingston: J Troeth D Martin T Crane T Gardner R Jiannis J Millie					<b>BEST:</b> Naracoorte: M Maney F Taylor X Mitchell Z Boston J Lawrie L Leehane. Kingston: J Booker L Braithwaite J Peterson Z Hatch J Murdock J Pope					<b>BEST:</b> Bordertown: A Dahlitz C Jolly J Will C Orrock D Twigden H Wainohu. Keith: A White A Nutt C Parker W Hedges L Hedges H O'loughlin																		
<b>KEITH</b>	0.5	1.8	3.12	5.13	(43)		<b>KEITH</b>	3.4	7.10	13.14	17.22	(124)	<b>NARACOORTE</b>	4.3	12.5	15.8	15.8	(98)	<b>BORDERTOWN</b>	3.5	4.5	6.11	7.12	(54)											
<b>BORDERTOWN</b>	1.2	1.6	1.7	2.8	(20)		<b>BORDERTOWN</b>	0.2	0.2	0.3	1.3	(9)	<b>KINGSTON</b>	1.1	1.2	1.3	1.3	(9)	<b>KEITH</b>	0.0	3.1	3.1	4.1	(25)											
<b>GOALS:</b> Keith: B Wade 2 L Green L Hender J Lush. Bordertown: L Crawford J Eats							<b>GOALS:</b> Keith: C Dix 5 H Dix 4 J Trowbridge 3 H McMurray 2 J Irwin 2 J Sigston. Bordertown: D Camemolla					<b>GOALS:</b> Bordertown: H Hayes 3 N Mccarthy 2 C Partridge H Meakins A Hampel. Keith: T Oliver					<b>GOALS:</b> Kybybolite: C Nolan 3 B Watson J Ottoson-Crossling S Tierney L Brodie. Lucindale: A Charlick																		
<b>BEST:</b> Keith: J Wilson N Van Den Berg B Wade G Thring R Bartlett J Lush. Bordertown: M Leigh J Searle R Tink H Shuttleworth B Jarrett S Trenorden							<b>BEST:</b> Keith: J Sigston C Dix Z Martin H Dix L Johnson H McMurray. Bordertown: Z Mclellan G Twigden A Lange S Exton K Tink					<b>BEST:</b> Bordertown: C Will H Dahlitz N Mccarthy B Rodert H Meakins H Hayes. Keith: E Wood T Wilson B Ross D Willis J Smith T Rosenzweig					<b>BEST:</b> Kybybolite: S Freckleton S Tierney J Ottoson-Crossling C Nolan M Crossling K Sears. Lucindale: T Longbottom L Jenke E Ward T Raedel S Buick F Dennis																		
<b>LUCINDALE</b>	5.1	8.7	13.11	18.18	(126)		<b>LUCINDALE</b>	2.3	6.5	10.12	15.16	(106)	<b>NARACOORTE</b>	4.3	12.5	15.8	15.8	(98)	<b>PENOLA</b>	4.1	6.2	10.4	11.4	(70)											
<b>KYBYBOLITE</b>	3.1	8.5	10.6	10.7	(67)		<b>KYBYBOLITE</b>	1.1	3.2	3.2	4.3	(27)	<b>KINGSTON</b>	1.1	1.2	1.3	1.3	(9)	<b>BORDER DISTRICTS</b>	1.0	1.1	1.2	1.3	(9)											
<b>GOALS:</b> Lucindale: H Gordon 5 R Mcfarlane 3 L May 2 J Trembath 2 H Tregoweth 2 B Mccarthy 2 S Foord-Spriggs N Cane. Kybybolite: S Craig 4 B Laurie 3 B Carberry J Bittner B Castine							<b>GOALS:</b> Lucindale: D Sherwin 2 R Wilkin 2 N Clarke 2 S Pitt 2 T Ware S Graetz S Sherwin S Clothier M Baker H Legoe B Teakle. Kybybolite: M Slotegraaf 3 S Shepherd					<b>GOALS:</b> Lucindale: M Bittner 4 J Schutz 2 A Pitt 2 R Clarke. Kybybolite: R Southern					<b>GOALS:</b> Penola: B Copping 4 G Berkin 3 J Crawford 2 W Harris O Braun B Lear. Border Districts: H Brodie																		
<b>BEST:</b> Lucindale: B Mccarthy L Kelsh H Gordon A Mccarthy T Logan L May. Kybybolite: C Masters S Munn S Craig B Laurie D Brodie J Bittner							<b>BEST:</b> Lucindale: J Walker S Pitt J Teakle D Robb S Sherwin N Clarke. Kybybolite: J Cavill D Ewerr B Wallis B Ludwig P Werchowski L Bull					<b>BEST:</b> Lucindale: W Graetz M Bittner P Fraser E Hocking A Pitt B Thornhill. Kybybolite: S Shepherd M Garwood J Shepherd R Castine D Grigg					<b>BEST:</b> Penola: B Copping G Berkin F Skeer O Braun B Lear C Pearce. Border Districts: F Boddington L Moss W Hausler S Buckley E Koch A Bradley																		
<b>BORDER DISTRICT</b>	4.4	10.8	15.11	18.15	(123)		<b>PENOLA</b>	5.2	7.7	13.9	18.12	(120)	<b>P'WAY LUCINDALE</b>	5.1	8.5	8.8	9.10	(64)	<b>PENOLA</b>	4.1	6.2	10.4	11.4	(70)											
<b>PENOLA</b>	2.1	4.2	7.2	9.4	(58)		<b>BORDER DISTRICT</b>	0.2	1.5	1.6	4.7	(31)	<b>KYBYBOLITE</b>	0.3	0.3	1.3	1.3	(9)	<b>BORDER DISTRICTS</b>	1.0	1.1	1.2	1.3	(9)											
<b>GOALS:</b> Border District: D Auciello 6 M Coles 5 H Pretlove 2 B Helyar 2 M Quinn J Helyar C Gardner. Penola: L Walker 2 C Brand S Gartner G Eckermann S Merrett Z Deane B Bryant J Pfizner							<b>GOALS:</b> Penola: M Devereux 9 L March 2 T Clayfield 2 S Zadow Z Currie O Bennett H Lambert. Border District: L Nicholas 2 J Iese 2 P Rogers					<b>GOALS:</b> Lucindale: M Bittner 4 J Schutz 2 A Pitt 2 R Clarke. Kybybolite: R Southern					<b>GOALS:</b> Penola: B Copping 4 G Berkin F Skeer O Braun B Lear C Pearce. Border Districts: F Boddington L Moss W Hausler S Buckley E Koch A Bradley																		
<b>BEST:</b> Border District: N Naylor M Quinn D Stirling Z Edwards B Helyar D Auciello. Penola: K Messenger B Bryant B Egan J Robbie P Lambert Z Deane							<b>BEST:</b> Penola: C Merrett M Devereux C Lythgo L March J Doyle M Merrett. Border District: A Pitt H Kroemer M Fulton W Rata J Iese C Cardwell					<b>BEST:</b> Lucindale: W Graetz M Bittner P Fraser E Hocking A Pitt B Thornhill. Kybybolite: S Shepherd M Garwood J Shepherd R Castine D Grigg					<b>BEST:</b> Penola: B Copping G Berkin F Skeer O Braun B Lear C Pearce. Border Districts: F Boddington L Moss W Hausler S Buckley E Koch A Bradley																		
LADDER							LADDER					LADDER					LADDER																		
	P	W	L	D	F	A	%	Pts		P	W	L	D	F	A	%	Pts		P	W	L	D	F	A	%	Pts									
Lucindale	14	12	2	0	1369	789	173.51	48	Lucindale	14	12	2	0	1227	482	254.56	48	Naracoorte	14	13	1	0	1178	350	336.57	52	Naracoorte	12	12	0	0	708	136	520.59	48
Mundulla	14	10	3	1	1085	803	135.12	42	Keith	14	12	2	0	1052	475	221.47	48	Bordertown	14	10	4	0	928	544	170.59	40	Kybybolite	12	10	2	0	708	154	459.74	40
Keith	14	10	4	0	1223	841	145.42	40	Mundulla	14	10	4	0	1467	478	306.9	40	Mundulla	14	9	5	0	982	889	110.46	36	Bordertown	13	9	4	0	512	233	219.74	36
Kingston	14	9	5	0	982	889	110.46	36	Naracoorte	14	10	4	0	1025	462	221.86	40	Naracoorte	14	8	6	0	1325	991	133.7	32	Penola	13	7	6	0	498	429	116.08	28
Naracoorte	14	8	6	0	1325	991	133.7	32	Kybybolite	14	8	6	0	982	679	144.62	32	P'way Lucindale	14	8	6	0	750	661	113.46	32	Mundulla	14	7	7	0	799	661	120.88	28
Border District	14	6	8	0	911	1008	90.38	24	Kingston	14	7	7	0	825	1033	79.86	28	Mundulla	14	7	7	0	799	661	120.88	28	Keith	14	6	8	0	567	740	76.62	24
Padthaway	14	6	8	0	885	1066	83.02	24	Penola	14	6	8	0	738	946	78.01	24	Keith	14	6	8	0	567	740	76.62	24	Kingston	14	2	12	0	410	1111	36.9	8
Bordertown	14	4	9	1	830	1038	79.96	18	Bordertown	14	3	11	0	564	842	66.98	12	Kingston	14	2	12	0	410	1111	36.9	8	Penola	14	1	13	0	257	1211	21.22	4
Kybybolite	14	3	11	0	818	1235	66.23	12	Padthaway	14	2	12	0	513	1386	37.01	8	Penola	14	1	13	0	257	1211	21.22	4									
Penola	14	1	13	0	679	1447	46.92	4	Border District	14	0	14	0	408	2018	20.22	0																		



# Eagles on track for finals

By Trevor Jackson

**Hatherleigh 23.18 (156) d Kongorong 8.9 (57)**

A strong opening term provided Hatherleigh with the perfect starting point to secure a solid victory over Kongorong in Round 16 of Mid South East football on Saturday.

The Eagles travelled to face the Hawks and were never in trouble, much of that on the back of an eight-goal haul from Sam Telfer.

Telfer was in fine touch up forward and made the most of good delivery to ensure the Eagles were on track as the post-season fast approaches.

A seven-goal opening term set the scene, with the home side only able to add two majors before the first break.

Hatherleigh extended the margin in the second quarter, adding a further six majors to a solitary goal from Kongorong.

The Hawks were held goal-less in the third term but managed to find some extra spark in the final stanza to bang on five majors.

However, the Eagles added a further six majors to run the game out.

Telfer was joined by another seven goal kickers, with Patrick Chay and coach Jake Dowdy registering four each, while Brad Mitchell rounded out the multiple goal scorers with two.

Dowdy said it was a solid effort for three quarters, with the heavy conditions taking their toll as the game would down.

However, he said with the last-round loss to Glencoe, it was important his players responded.

"We had to respond to the loss to Glencoe



Hatherleigh's Mark Marriott kicks clear under pressure during a best-on-ground performance for the victorious Eagles.  
Picture: TREVOR JACKSON

... we were disappointed with that," he said.

"We had a point to prove and the boys came out strong from the start."

The Eagles had plenty of options up forward and Dowdy noted the importance of delivering the ball well, which he said was on display in the opening half of the contest.

"In the first half our kicking to advantage was outstanding," he said.

"Sam Telfer is not tall, he is quick and we just kicked out in front of him.

"Patty Chay is a tall but you kick out in front

of him it gives him the best option.

"With the forward line we have, if the ball is out in front I would back them in to win it nine times out of 10."

With those two players - and Dowdy - topping the goal kicking list, it was the goal-less ruckman Mark Marriott who was named best player.

That cam by no mistake and Dowdy gave him a big rap.

"In the first half he killed it," he said.

"He is not just a ruckman but plays like an-

other on-baller.

"In the first half I thought he was unreal with his second and third repeat efforts.

"For a big man you don't expect it but he set the tone for all our little fellows and the whole team."

While Hatherleigh and Kongorong are virtually at opposite ends of the premiership table, Dowdy said you would not have known it throughout the game, despite the lop-sided score.

"Last time we played them we won by more but it doesn't feel like that on the field, they are so competitive," he said.

"They played some good football throughout the day and hit the ball hard."

With that in mind, Dowdy said it was important the Eagles were off to a solid start to set the tone of the game after coming off a loss.

"We have lost three games to teams below us so Kongorong were probably thinking if we didn't turn up they would be a good chance," he said.

"I stressed to my boys we needed to put that behind us, we know how good our good football can be and we just needed to play with that consistency.

"We have had a few hiccups this season but that's football.

"The main thing is how you recover from it and go on.

"We have a fair belief in the group with what we can do, so I was pleased with how the boys responded."

## Eagle-eyed determination proves too much for Hawks

**Hatherleigh 52 d Kongorong 30**

Hatherleigh worked hard to build a winning margin against Kongorong in Round 16 of Mid South East netball on Saturday.

The Hawks were off to a great start, turning over the Eagles first centre and shooting the first couple of goals unanswered.

However, Hatherleigh's Demi Vanderhorst was on from the first whistle, working hard in the circle to apply pressure down the Hawks end of the court.

At the other end of the court, the Hawks defensive line of Riley Buckingham, Emily Lightbody and Sarah Lucas took a while to adjust to the Eagles quick ball movement.

The Eagles were able to capitalise thanks



Hatherleigh's Abby Wight takes clean possession during the Eagles win over Kongorong.

to Abby Wight and Maddie Redman's accuracy in the circle to take a one-goal lead to the first break.

The second quarter saw the defensive pressure from both teams lift.

Redman and Buckingham battled hard in the circle, both influential for their respective sides.

Tegan Telfer and Georgia Hunter turned it up another gear and the Eagles remained composed and displayed patience and skill through their mid court, pushing their lead out to six goals at the main break.

The Hawks went into the third quarter with plenty of work to do, Lucas and Buckingham not missing a beat in defence, capitalising on any 50/50 balls and rebounding strongly.

However, their efforts were rarely rewarded as the Hawks struggled with poor feeding and missed shots and were unable to capitalise.

At the other end of the court the Eagles defenders were also finding their groove, with Vanderhorst and Lara MacGregor taking advantage of the Hawks poor ball use and were finding hands all over the court to capitalise on any missed shots.

The Eagles played possession ball and outscored the Hawks 11-4 to further extend their lead.

The pressure continued in the final term but it was Hatherleigh that kept the momentum going and ran out comfortable victors.

Vanderhorst and MacGregor were named best for the victors, while Lucas and Tilah Buckingham received the honours for the Hawks.

## WESTERN BORDER FOOTBALL LEAGUE

A GRADE		RESERVES		UNDER 17s		UNDER 14s	
<b>NORTH GAMBIER</b>	<b>1.0 4.4 6.4 8.10 (58)</b>	<b>WEST GAMBIER</b>	<b>1.0 7.2 8.9 16.11 (107)</b>	<b>NORTH GAMBIER</b>	<b>1.5 6.9 8.11 9.11 (65)</b>	<b>NORTH GAMBIER</b>	<b>2.1 3.5 7.8 9.9 (63)</b>
<b>WEST GAMBIER</b>	<b>5.3 5.3 7.7 8.8 (56)</b>	<b>NORTH GAMBIER</b>	<b>3.1 4.1 5.2 6.4 (40)</b>	<b>WEST GAMBIER</b>	<b>0.1 0.2 2.3 3.3 (21)</b>	<b>WEST GAMBIER</b>	<b>2.3 3.5 3.5 4.7 (31)</b>
<b>GOALS:</b> North Gambier A Grade: D Bachmann 3 T De Wit 2 N Moretti S Stafford J Griffith. West Gambier A Grade: M Cornolo 3 R Cowling 2 D Gillies J Williams T Nieuwerkerk		<b>GOALS:</b> West Gambier: J Schapel 7 C Wagstaffe 2 J Hewett 2 J Coombe J Carson J Waugh N Lewis C Carson. North Gambier: S Shepherd 2 W Thompson A Widdison E Norman J Arthurson		<b>GOALS:</b> North Gambier: C Milhouse 2 B Dethmore 2 Z Clark J Millard A Dally E Williamson Z Young. West Gambier: S Medhurst J Day L Paku		<b>GOALS:</b> North Gambier: I Coleman D Ilsley I Phutt C Turner C Mclaughlin R Kinyabugma A Dally B Anderson. West Gambier: S Fraser T Johnson K Harkness J Prior	
<b>BEST:</b> North Gambier A Grade: C Buckley B Shepherdson J Schutz T De Wit J McConnell D Bachmann. West Gambier A Grade: K Giddings T Redden D Robbins M Cornolo W Crook		<b>BEST:</b> West Gambier: J Schapel C Wagstaffe T Cleveland J Carson J Waugh. North Gambier: T Young D Poyner S Shepherd J Arthurson A Widdison Z Clark		<b>BEST:</b> North Gambier: B Allen R Mclaughlin A Dally D Ilsley. West Gambier: N Davey S Than B Boulit M Byfield T Smith		<b>BEST:</b> North Gambier: S Doody J Du Toit I Phutt T Stephens C Mclaughlin. West Gambier: R Case S Bowden K Harkness N Pearce B Cowling B Winterfield	
<b>CASTERTON S'FORD</b>	<b>2.2 7.7 7.12 13.12 (90)</b>	<b>CASTERTON S'FORD</b>	<b>4.5 9.9 13.11 15.16 (106)</b>	<b>SOUTH GAMBIER</b>	<b>2.2 8.5 9.5 12.8 (80)</b>	<b>CASTERTON S'FORD</b>	<b>1.2 1.2 4.4 7.5 (47)</b>
<b>EAST GAMBIER</b>	<b>4.1 5.3 10.5 10.8 (68)</b>	<b>EAST GAMBIER</b>	<b>0.1 0.3 0.3 0.3 (3)</b>	<b>MILLICENT</b>	<b>2.2 2.2 3.3 3.3 (21)</b>	<b>EAST GAMBIER</b>	<b>2.0 2.2 3.2 4.4 (28)</b>
<b>GOALS:</b> Casterton S'ford A Grade: H McCrae 4 A Mckinnon 3 D Cleary 2 C Jarrad 2 E Currie J Thompson. East Gambier A Grade: S Lock 4 G Ha 2 M Scanlon 2 P Hatch D Hunt		<b>GOALS:</b> Casterton S'ford: P Hutchins 5 M Kurzman 4 J Smith 2 M Jarrad 2 F Bright J Fitzgerald. East Gambier: Nil.		<b>GOALS:</b> South Gambier: L Turley 3 N Adams J Chuck L Winterfield L Broome F Lawson H Fisher N Forbes L Thiele N Wilke. Millicent: A Wesolowski 2 H Damhuis		<b>GOALS:</b> Casterton S'ford: S Craig 4 R Makore M Bright. East Gambier: E Stratford	
<b>BEST:</b> Casterton S'ford A Grade: A Mckinnon D Ayton J Carlin Z Nash D Cleary E Currie. East Gambier A Grade: J Eldridge S Lock G Ha M Ferguson J Forster		<b>BEST:</b> Casterton S'ford: D Carlin C Wombwell J Smith M Jarrad P Milich C Zippel. East Gambier: C Todd C Little T Williamson T Gilbert A Scott R Allen		<b>BEST:</b> South Gambier: S Sims L Thiele L Broome C Fielding S Wastell J Chuck. Millicent: A Fuller T Lang P Jennings T Dunn J Dean R Redway		<b>BEST:</b> Casterton S'ford: S Craig B Mckinnon S Gibbs R Makore P Ferreira. East Gambier: K Chittleborough N Gollan E Stratford	
<b>MILLICENT</b>	<b>2.4 8.5 10.10 13.11 (89)</b>	<b>SOUTH GAMBIER</b>	<b>5.2 8.5 11.9 15.11 (101)</b>			<b>SOUTH GAMBIER</b>	<b>2.2 4.2 5.2 6.4 (40)</b>
<b>SOUTH GAMBIER</b>	<b>1.2 2.5 3.7 6.8 (44)</b>	<b>MILLICENT</b>	<b>0.0 2.0 2.1 2.2 (14)</b>			<b>MILLICENT</b>	<b>1.1 3.3 4.3 5.3 (33)</b>
<b>GOALS:</b> Millicent A Grade: D Bromley 7 T Hutchesson 2 S Willis C Williams K Varcoe J Carger. South Gambier A Grade: B Keding M Sims E Fisher B Foster B Kain P Glynn		<b>GOALS:</b> South Gambier: K Eagleson 9 S Mctaggart 2 H Mcbain R Hein C Williams T Laube. Millicent: T Chant D Shanks		<b>GOALS:</b> South Gambier: J Maxwell 2 L Ray 2 I Bouchier M Whitehead. Millicent: H Gibbs 3 J Bowden K Gibson		<b>BEST:</b> South Gambier: C Lockwood L Ray I Bouchier A Milich J Sims. Millicent: J Dean H Gibbs K Gibson A Lindner J Werchon	
<b>BEST:</b> Millicent A Grade: S Willis J Cushion J Todd D Bromley K Varcoe F Bradley. South Gambier A Grade: B Keding T Saffin C Fallas T Reid J Paprotny M Sims		<b>BEST:</b> South Gambier: S Mctaggart K Eagleson H Mcbain C Williams L Gray R Hein. Millicent: H Willis T Craig J Pratt D Shanks A Watts					
LADDER		LADDER		LADDER		LADDER	
	<b>P W L D F A % Pts</b>		<b>P W L D F A % Pts</b>		<b>P W L D F A % Pts</b>		<b>P W L D F A % Pts</b>
South Gambier	16 14 2 0 1465 881 166.29 56	South Gambier	16 16 0 0 1935 191 1013.09 64	South Gambier	13 13 0 0 1147 307 373.62 52	South Gambier	16 16 0 0 1300 201 646.77 64
Millicent	16 13 2 1 1197 795 150.57 54	Millicent	16 11 5 0 1014 776 130.67 44	North Gambier	13 9 4 0 848 567 149.56 36	North Gambier	16 9 7 0 784 672 116.67 36
North Gambier	16 7 9 0 1127 1077 104.64 28	West Gambier	16 9 7 0 837 852 98.24 36	Millicent	13 6 7 0 853 609 140.07 24	Millicent	16 7 8 0 560 743 75.37 28
West Gambier	16 6 9 1 880 1034 85.11 26	Casterton S'ford	16 6 10 0 664 975 68.1 24	West Gambier	13 3 10 0 559 931 60.04 12	Casterton S'ford	16 7 9 0 477 787 60.61 28
Casterton S'ford	16 6 10 0 959 1358 70.62 24	North Gambier	16 5 11 0 630 1203 52.37 20	East Gambier	16 4 11 1 504 837 60.22 18	East Gambier	16 4 11 1 504 837 60.22 18
East Gambier	16 1 15 0 859 1342 64.01 4	East Gambier	16 1 14 0 384 1467 26.18 4	East Gambier	12 1 11 0 219 1212 18.07 4	West Gambier	16 4 11 1 519 904 57.41 18



# Bay boys right on track

By Trevor Jackson

**Port MacDonnell 28.17 (185) d  
Tantanoola 9.10 (64)**

It was certainly the day for the top four sides in Round 16 of Mid South East football on Saturday.

Port MacDonnell cemented its finals berth with a big win over Tantanoola, despite a change of venue.

The Demons were set to host the game but the recent rains took their toll and the game went ahead at Tantanoola.

Port MacDonnell coach Simon Merrett said Tantanoola had asked for the change and he was happy to give the ground a break.

"Tantanoola wanted to change the venue and the league ticked off on it," he said.

"We had 49mm of rain from the Sunday until Thursday night leading up to the game.

"There were a few spots that were a big ragged but mainly surface water across it.

"We only started training on it in March and it was right on the verge of getting on when we did.

"I think about 10 per cent of it needs to be redone but what is there is really good.

"It just needs a summer to firm up and it will be fine."

To keep the trend of the round going, the Demons hit the ground running and held a 37-point advantage at the first break.

They simply extended that advantage as the game unfolded to run out convincing victors.

Will MacDonald and Jake Turner shared the spoils up forward, with five goals each, while Wade Chant, Alex Ridding and Tim Sullivan added two each.

In total, 14 Demons contributed to the winning score.

In contrast the Tigers had six contributors, with coach Jak Ryan the best with three majors, while Ryan Simmons added two.

Merrett said it was pleasing to see such a strong start to the game, which laid the foundations of a good day at the office.

"We have been not as good out of the blocks as we were last year, so it was definitely a focus area (Saturday)," he said.

"To put up 50-odd points in the first quarter was pleasing.

"I think we had 25 shots at half time from 30 inside 50s, so we were going at a pretty good clip when we got it in there.



Port MacDonnell's Ned Wilke continued his good form on the weekend in the Demons solid victory over Tantanoola.

Picture: FILE IMAGE

"Defensively there were a few things we had to tweak at half time but I was pretty happy with the outcome."

Likewise, Merrett was just as pleased with the contribution of his players in front of goal.

The 14 individual goal kickers made it a tough task for the Tigers to defend.

"Our spread has been great," he said.

"We are not really focused on one person - it is great to have Will (MacDonald) up there firing but we have shown we have plenty of different avenues to kick goals, which should hold us in good stead the next few weeks."

The Demons have played with positional changes this season and more recently as the finals fast approach.

The likes of Kevin Thomson playing more of a backman's role has provided some good

opportunities up forward, with his accurate delivery inside ideal for the leading players.

Merrett said he would continue to play with positional changes leading up to the finals to ensure the Demons are every chance of success.

"We have a plan A and a plan B and we have a lot of variety in each role," he said.

"Everyone is capable of playing different positions if we have to throw things around.

"We played a fifth colt on the weekend, so we are getting games into the next batch coming through and looking to the future a bit more.

"To be able to win and sit where we are on the ladder while doing that is pleasing."

Considering the losses the Demons faced from the 2021 premiership side, it would be

fair to say they have overachieved this season.

Merrett suggested that would be an accurate assumption.

"I think down at the club we would all agree we have overachieved," he said.

"We started the year with 11 blokes from the premiership side in the group and we lost 20 from our squad.

"The Mount Burr and Robe games we lost were by a goal between them.

"We are going better than we thought and that is a credit to the group who have done the work and bought into the things we have tweaked.

"Right now we are where we want to be and the last few weeks we have got it together.

"We think if we can win a final and get to that last three it will be a successful season."

## At a disadvantage, Tigers record hard-fought win

**Tantanoola 54 d Port MacDonnell 46**

Port MacDonnell lost its home-ground advantage for Round 16 of Mid South East netball, instead heading to Tantanoola for a tough contest.

The Demons went into the game without reliable defender Belinda O'Dine, so were forced to shuffle their lineup around slightly and send shooter Kirby Carrison to goal keeper.

The first quarter started evenly and was fast paced, with all goalies taking time to settle.

Tantanoola's Emma Gould was able to rebound most of her missed shots and get a second chance.

Liza Mutch was impressive early in the centre for the Demons and kept Tiger Madi Kelly on her toes.

Narelle Lewis was also dominant for the Demons on the attacking wing, driving into space with patience around the ring.

The Tigers went to the first break with a four-goal advantage.

The start of the second quarter saw Toni Gilmore find her range in the Demons' goal circle, missing just one for the quarter.

Gould was dominant at the other end of the court, despite Carrison's best efforts, while Demon defender Alana Winter was

able to keep Tiger Jami Walker relatively under control in the circle.

The Tigers defence line of Kate Bromley and Tayla Rowe started to find some form and got their hands to a lot of ball late in the quarter.

The Tigers only won the quarter by two goals but extended their lead to six at the main break.

Port Mac brought 17 and Under player Lara Wilson into goal attack, while Williams had a break.

Wilson took no time to settle, shooting nine goals for the quarter, while Rowe kept Gilmore to just two.

Gould had a brilliant third quarter, shooting 14 goals with few misses.

Casey Walker was impressive around the circle, feeding her goalies with pinpoint accuracy.

As a result Tantanoola created some much-needed space and took an 11-goal advantage to the final break.

Gould missed a few goals for the term as the Demons claimed the quarter but it was not enough to close the gap and the Tigers claimed a well-deserved eight-goal victory.

Casey Walker and Rowe were best for Tantanoola, while Mutch and Lewis claimed the honours for the Demons.



Tantanoola's Tayla Rowe played a strong defensive game in the Tigers' win over Port MacDonnell on Saturday.

Picture: FILE IMAGE



# Magpies deadly at goals

By Trevor Jackson

**Kalangadoo 32.10 (202) d Robe 6.6 (42)**

It was a tough day on the road for Robe in Round 16 of Mid South East football on Saturday.

The Roosters travelled to face a tough Kalangadoo outfit and the result suggested the Magpies are on track for a successful finals campaign.

Accuracy has been somewhat of a problem for the Magpies this season but that all changed on Saturday, with just 10 minor scores alongside the 32-goal haul.

The victory came after a steady opening term, where the Roosters were right in the contest, trailing by just seven points at the first break.

However, the Magpies then found their feet and began to pepper the big sticks, with 12 majors in the second quarter.

They added six more in the third term, before running the game out with an 11-goal final quarter burst.

Michael Krieger returned his biggest haul of the season with 12 majors, to now sit on 73 goals for the season from 13 games.

Krieger was rightly named best for the Magpies and was among a long list of 10 goal kickers.

Ben Gregory (5), Patrick Davies (4), Lachy Jones (3), Alex Lyon (2) and Andrew Stone (2) all kicked multiples, while a few others added single majors.

After an even first term, coach Kevin Stark made a few minor changes at the first break and the Magpies began to play their best football.

"I thought the first quarter was a real contest, which was good, then we had a chat about a couple of things and made a few little adjustments," he said.

"We just spoke about how we wanted to move the ball going forward and from there we were able to turn it around a bit, which was good.

"I think we generated 16 scoring shots in



Kalangadoo's Mitch Lowe moves the ball forward during the Magpies' big win over Robe.

Picture: LACHLAN ONIONS

the second quarter so we were much happier with how we went about it."

As for Krieger's 12-goal effort, Stark simply said 'he had a very good day'.

"He is good in the air and just as good when he hits the ground," he said.

"He does it so consistently you sort of half expect it.

"He spends a bit of time in the mid-field too and still manages to hit the goals."

Part of the plan this season is to bring young players into the fold and that was the case on Saturday, with Brad Male, Connor Gentile and Jack O'Connor all in the lineup.

Stark said the youngsters not only filled a space but also contributed well.

"We have one regular senior colt in the lineup and brought two more in," he said.

"They played unbelievably good games.

"It is good to see they come in and play their role and do their job without any hiccups.

"We had Brad Male in the ruck and he has a crazy vertical leap.

"Connor Gentile has exquisite skills and it is the same with Jack O'Connor, who is an unbelievably hard-working footballer.

"All three, when they get the ball they don't panic, they have beautiful kicks, they pick their target and nine times out of 10 they lace it out."

The Magpies' best players list is indicative of how they play their football.

Stark said it showed a good mix of midfielders, backmen and forwards.

He said it was a tough prospect to pick the best players, considering the way the side is performing, which clearly shows in the suc-

cess so far this season.

"The thing I like in the second half of the season is the even contribution from everyone," Stark said.

"Everyone is doing their job and we don't have eight to 10 people carrying the team."

Kalangadoo faces Tantanoola this weekend, before a big hitout in the final minor round against Hatherleigh.

"I and very happy with where we are at this time of the year," Stark said.

"But we are well aware as a group, come finals, if we get Hatherleigh or Port Mac in that first game, we have to make sure everyone is switched on and working hard.

"I like the fact we have Hatherleigh the week before finals, which will be a good test for the group to see where we are at."

## MID SOUTH EASTERN FOOTBALL LEAGUE

A GRADE											RESERVES					UNDER 17s					UNDER 14s																						
<b>PORT MACDONNELL</b>	8.3	13.12	21.14	28.17	(185)	<b>HATHERLEIGH</b>	4.5	12.9	17.14	21.19	(145)	<b>HATHERLEIGH</b>	3.3	6.5	9.7	11.9	(75)	<b>KONGORONG</b>	1.2	1.3	2.6	6.6	(42)																				
<b>TANTANOOLA</b>	2.2	5.6	8.8	9.10	(64)	<b>KONGORONG</b>	0.1	0.1	0.2	0.2	(2)	<b>KONGORONG</b>	2.1	3.3	4.4	6.4	(40)	<b>HATHERLEIGH</b>	0.0	0.0	0.0	0.1	(1)																				
<b>GOALS:</b> Port Macdonnell: W Macdonald 5 J Turner 5 A Ridding 3 T Sullivan 3 W Chant 3 B Newton A Lamb E Gladman J Schleter S Merrett N Wilke N Brotherton K Thomson. Tantanoola: J Ryan 3 R Simmons 2 B Pitts Z Walker B Reilly C Barrett						<b>GOALS:</b> Hatherleigh: T Merrett 5 T Bell 5 L Brown 3 C Skeer 3 M Telfer 3 W Oconnor R Lindner. Kongorong: Nil.						<b>GOALS:</b> Hatherleigh: H Jones 8 B Werchon J Atkinson A Nettle. Kongorong: B Von Stanke-Dowie 2 T Bellinger 2 S Von Stanke T Richardson						<b>GOALS:</b> Kongorong: R Lucas 2 K Galloway A Page J Gordon H Elletson. Hatherleigh: Nil.																									
<b>BEST:</b> Port Macdonnell: T Sullivan K Thomson W Chant W Macdonald N Wilke N Brotherton. Tantanoola: R Simmons J Hatt Z Walker T Hatt A Roberts						<b>BEST:</b> Hatherleigh: A Reid W Oconnor C Slape J Wight C Skeer J Gilbertson. Kongorong: W Cameron D Hann L Pulford D Robinson S Farrell						<b>BEST:</b> Hatherleigh: H Jones Z Bowering B Werchon T Atkinson J Bellinger. Kongorong: B Von Stanke-Dowie C Janeway R Newton J Allen H Elletson						<b>BEST:</b> Kongorong: R Lucas A Page N Von Stanke-Dowie H Elletson D Richardson L Allen. Hatherleigh: T Bowering E Marshall O Howell C Taylor C Bellinger																									
<b>MT BURR</b>	15.5	22.9	32.14	41.20	(266)	<b>TANTANOOLA</b>	5.7	8.10	12.12	15.16	(106)	<b>TANTANOOLA</b>	3.0	6.5	8.7	8.8	(56)	<b>PORT MACDONNELL</b>	4.3	11.4	14.5	20.8	(128)																				
<b>NANGWARRY</b>	1.1	1.1	3.3	4.3	(27)	<b>PORT MACDONNELL</b>	2.1	6.1	8.3	8.4	(52)	<b>PORT MACDONNELL</b>	3.1	5.1	5.4	5.9	(39)	<b>TANTANOOLA</b>	0.1	0.1	1.2	1.2	(8)																				
<b>GOALS:</b> Mt Burr: H Smith 9 J Gregory 7 B Hennink 5 J Wallis 4 W Bowering 3 T Allen 2 D Ridley 2 G Whennen 2 B Sharp R Gamble J Fiebig R Duncan N Muhovics. Nangwarry: A Hyland 3 T Badman						<b>GOALS:</b> Tantanoola: D Hogan 5 C Saint 3 C Hamilton 2 M Sporer M Nelson J Bromley N Chapple N Bell. Port Macdonnell: M Brown 4 A Richards 2 J Spehr R Von Stanke						<b>GOALS:</b> Port Macdonnell: D Habner 2 K Gilmore W Lewis L Richards						<b>GOALS:</b> Port Macdonnell: K Gilmore 6 J Lewis 3 C Wilson 2 T Neale 2 T Howard 2 J Virgo T Dennert L Bowd Z Lewis. Tantanoola: J Bevan																									
<b>BEST:</b> Mt Burr: H Smith W Bowering T Allen T Stanley J Gregory B Hennink. Nangwarry: J Virtanen J Mills A Hyland J Pudney B Just T Badman						<b>BEST:</b> Tantanoola: T Mcgrath J Bromley M Nelson C Saint C Hamilton M Langley. Port Macdonnell: F Lynch J Newton-Anderson T Newton M Brown G Hutchesson J Carrison						<b>BEST:</b> Tantanoola: S Simmons R Simmons K Bell C Baker B Scanlon E Bowman. Port Macdonnell: K Gilmore R Morgan A Lamb H Tickle L Richards E Perryman						<b>BEST:</b> Port Macdonnell: K Gilmore H Carroll N Perryman Z Smith J Lewis C Wilson. Tantanoola: E Bowman J Bevan K Bell Z Linnell K Shawyer																									
<b>KALANGADOO</b>	3.2	15.6	21.7	32.10	(202)	<b>MT BURR</b>	2.8	5.9	6.11	8.13	(61)	<b>MT BURR</b>	3.4	8.5	10.7	14.9	(93)	<b>MT BURR</b>	3.1	5.2	8.4	9.6	(60)																				
<b>ROBE</b>	2.1	3.1	5.4	6.6	(42)	<b>NANGWARRY</b>	2.1	2.1	6.3	8.4	(52)	<b>NANGWARRY</b>	0.1	2.1	2.1	3.2	(20)	<b>NANGWARRY</b>	0.0	0.2	1.3	4.5	(29)																				
<b>GOALS:</b> Kalangadoo: M Krieger 12 B Gregory 5 P Davies 4 L Jones 3 A Lyon 2 A Stone 2 M Davies B Mules J O'connor B Auld. Robe: J Kelly 2 T Miller 2 J Aston J Bryant						<b>GOALS:</b> Mt Burr: T Hales 2 M Teagle 2 S Evans 2 L Alcock Z Gray. Nangwarry: J Moore 5 C Hicks 2 V Virtanen						<b>GOALS:</b> Mt Burr: B Sharp 4 M Abduvahobov 3 B Lawson 2 C Carr 2 C Bevan N Manhood C Sparkes. Nangwarry: A Virtanen 2 H Stewart						<b>GOALS:</b> Mt Burr: C Bevan 6 D Brant 3. Nangwarry: C Bormann 3 H Thomson																									
<b>BEST:</b> Kalangadoo: M Krieger M Fatchen B Gregory B Auld M Davies A Stone. Robe: T Miller T Williams J Kelly J Hentschke J Pettit T Wachtel						<b>BEST:</b> Mt Burr: S Evans Z Gray J Poulish M Teagle N Telfer G Wimshurst. Nangwarry: A Heron J Moore M Chaplin S Brooksby J Clayfield C Bonney						<b>BEST:</b> Mt Burr: M Abduvahobov B Sharp B Sandow C Sparkes N Manhood C Montuori. Nangwarry: A Virtanen W Balshaw P Davis C Bormann T Dinnison T Bell						<b>BEST:</b> Mt Burr: D Brant H Johnston L Thiele R Gardiner J Burchell I Mitchell. Nangwarry: Details N/A.																									
<b>HATHERLEIGH</b>	7.3	13.6	17.11	23.18	(156)	<b>KALANGADOO</b>	6.2	12.3	16.4	19.8	(122)	<b>ROBE</b>	3.2	6.5	12.6	15.8	(98)	<b>ROBE</b>	5.1	6.6	10.11	12.13	(85)																				
<b>KONGORONG</b>	2.1	3.2	3.4	8.9	(57)	<b>ROBE</b>	0.1	2.1	2.2	3.3	(21)	<b>KALANGADOO</b>	2.2	4.4	7.6	8.8	(56)	<b>KALANGADOO</b>	0.0	0.0	0.0	0.0	(0)																				
<b>GOALS:</b> Hatherleigh: S Telfer 8 P Chay 4 J Dowdy 4 B Mitchell 2 J Wight J Skeer M Telford J Galpin. Kongorong: J Ryan 2 C Sandercock 2 M Waters H Evans A Lightbody J Attard						<b>GOALS:</b> Kalangadoo: S Agnew 12 T Jones 3 J Mansell 2 C Gibbs J Jones. Robe: A Strydom B Ling J Campbell						<b>GOALS:</b> Robe: C Weston 5 F Peel 2 J Bryant 2 K Carter 2 M Mckenny B Hayes H Peel S Moore. Kalangadoo: C Box 2 A New E Young B Male C Gentile C Mccann J Norman						<b>GOALS:</b> Robe: J Mckenny 4 C Moore 2 S Aitken 2 A Haggett J Hinchliffe B Carter. Kalangadoo: Nil.																									
<b>BEST:</b> Hatherleigh: M Marriott P Chay J Galpin S Telfer Z Jones. Kongorong: M Cordy M Waters J Whitty C O'dea A Lightbody J Attard						<b>BEST:</b> Kalangadoo: S Agnew J Mansell J Brennan D Jeffree J Searle T Jones. Robe: D Day E Samuel J Robertson S Ferguson J Wilson						<b>BEST:</b> Robe: K Carter F Peel J Bryant C Thomas C Weston. Kalangadoo: B Male J O'connor C Gentile T Jerome C Box J Norman						<b>BEST:</b> Robe: B Dew C Moore A Haggett J Hinchliffe C Hooper. Kalangadoo: J Box E Burr L Mccann M Monaghan A Cooper D Gibbons-Clark																									
LADDER											LADDER					LADDER					LADDER																						
	P	W	L	D	F	A	%	Pts				P	W	L	D	F	A	%	Pts				P	W	L	D	F	A	%	Pts				P	W	L	D	F	A	%	Pts		
Kalangadoo	14	13	1	0	2159	576	374.83	52	Hatherleigh	14	14	0	0	1764	193	913.99	56	Robe	14	14	0	0	1137	488	232.99	56	Kongorong	15	15	0	0	1067	313	340.89	60								
Hatherleigh	14	11	3	0	1812	731	247.88	44	Kalangadoo	14	13	1	0	1706	315	541.59	52	Hatherleigh	14	12	2	0	1110	639	173.71	48	Glencoe	14	13	1	0	961	352	273.01	52								
Port MacDonnell	14	10	4	0	1284	933	137.62	40	Glencoe	14	8	6	0	944	825	114.42	32	Kongorong	15	11	4	0	1350	825	163.64	44	Port MacDonnell	14	10	4	0	822	480	171.25	40								
Mt Burr	14	9	5	0	1283	1094	117.28	36	Kongorong	15	8	7	0	838	885	94.69	32	Mt Burr	14	9	5	0	978	841	116.29	36	Hatherleigh	14	8	5	1	550	374	147.06	34								
Robe	14	7	7	0	1039	1443	72	28	Robe	14	7	6	0	710	764	92.93	28	Kalangadoo	14	6	8	0	929	1004	92.53	24	Robe	14	6	7	1	517	605	85.45	26								
Glencoe	14	6	8	0	1044	1220	85.57	24	Nangwarry	15	5	10	0	658	1088	60.48	20	Tantanoola	13	5	8	0	789	863	91.43	22	Robe	14	6	7	1	517	605	85.45	26								
Kongorong	15	4	11	0	1074	1525	70.43	16	Tantanoola	14	5	9	0	586	1061	55.23	20	Glencoe	14	4	10	0	817	1237	66.05	16	Mt Burr	14	6	8	0	619	606	102.15	24								
Tantanoola	14	3	11	0	867	1611	53.82	12	Mt Burr	14	3	11	0	352	1455	24.19	12	Port MacDonnell	14	2	12	0	593	982	60.39	8	Nangwarry	15	4	11	0	503	734	68.53	16								
Nangwarry	15	1	14	0	751	2180	34.45	4	Port MacDonnell	14	1	13	0	442	1414	31.26	4	Nangwarry	14	0	14	0	704	1396	50.43	2	Tantanoola	14	1	13	0	454	1142	39.75	4								



# Mozzies dominate

By Trevor Jackson

**Mount Burr 41.20 (266) d Nangwarry 4.3 (27)**

Mount Burr made short work of its clash with Nangwarry in Round 16 of Mid South East football on Saturday.

The Mozzies hit the ground running with a huge 15-goal opening stanza to put the Saints on notice.

The barrage continued throughout the afternoon, with a 141 to 7 scoreline at the main break.

The Saints simply struggled to penetrate the Mozzies defensive efforts but did manage to find two majors in the third quarter.

In reply the Mozzies added a further 10, then went on with the job in the final quarter, with another nine majors to ice the game.

The ability of Mount Burr to find a goal kicker in the clear certainly kept the scorers busy, with Hamish Smith the best of the bunch with nine goals.

Jack Gregory added seven, Brodie Hennink five and Josh Wallis four.

Taylor Allen, Dylan Ridley, James Wallis and Geordie Whennen all contributed two, with a host of other adding single majors.

It was a win which pleased coach Reece Duncan after coming off a big loss to Kalangadoo and a bye last round.

"It was pleasing to get back on the winner's board," he said.

"It was nice for the guys to come out and show they were ready to role and get things back in the right direction before finals."

The opening term certainly put the Saints on notice, which Duncan said was a test for his players, to see if they were ready to go straight out of the box.

From there the four-quarter performance suggested they were up to the task.

"We set ourselves up to make sure we were ready to go and it was good to see the guys show they were," Duncan said.

"Then I put it to the guys at half time - are we hungry enough and driven enough to continue on and keep pressuring these blokes or are we happy with what we have done, that's good enough and just cruise through for the rest of the game?"

"To me you need to make sure you stay hungry and keep pushing against any side and don't give an inch, because as soon as you give an inch you can find yourself in trouble and

become complacent."

Heading into the game Duncan said he had no plans to rest players but simply wanted them to leave nothing out on the ground.

"I wanted the boys to come off after the game absolutely spent, to run the whole game out," he said.

"There were no free rides."

With 14 individual goal kickers, the Saints certainly had a tough job at the defensive end of the ground.

Duncan said there was no plan before the game to try to give as many players as possible to chance to score.

"We have our forward line set up and those players are our usual goal scorers," he said.

"It wasn't something I touched on, as in trying to get these blokes goals, it just happened naturally.

"They moved to the right spots and we pulled the trigger on certain kicks."

The Mozzies certainly appear to be on track to push hard into the finals series but Duncan has no thoughts on the post-season at this stage. He said the most important thing now was to concentrate on the game against Robe this weekend.

"Robe at Robe will be a tough test," Duncan said.

"They will be up and about - some of the scorelines haven't been favourable to them the last couple of weeks - but Robe is always tough down there.

"They have quality players and a good system.

"I am happy to be around the mark but I have said to the players, we haven't made finals until the final siren in the last game against Tantanoola, then we look at what is next.

"I just want to make sure we do the right thing, tick all the boxes and not get ahead of ourselves."

Hamish Smith was in fine form on Saturday, with nine goals to his name when Mount Burr made short work of Nangwarry. Picture: FILE



Mount Burr's Meg Fennell continued her good form against Nangwarry on Saturday. Picture: FILE

## Mozzies close in to claim honours over Saints

**Mount Burr 53 d Nangwarry 27**

Mount Burr looked to limit Nangwarry's opportunities in Round 16 of Mid South East netball on Saturday.

Saints shooters Ange Pratt and Tahlia Wilson combined well but the Mozzies denied entry to the goal circle.

Madi Haggett was solid at the defensive end, while at the attacking end Ebony Clark was the focal point and the Mozzies found her in good position, to take a 13-5 lead to the first break.

Nangwarry made changes in the defensive end and brought Alice Circelli on the court at wing defence in an attempt to wrestle back some momentum.

Mount Burr set a defensive zone through the centre, causing numerous turnovers, while Meg Fennell passed with accuracy from the wing.

The Mozzies showed patience in attack, looking to find the goalies close to the ring.

Zoe Brown combined well with Clark and

Mount Burr continued to build on its lead.

Laura Schultz went to goal attack and Fennell to centre as the Mozzies flirted with a changed lineup.

Haggett was dynamic in defence, causing turnovers before the Nangwarry goalies had the opportunity to score.

Mount Burr went to the final break with a 19-goal lead.

Mount Burr started strongly in the final term, despite Nangwarry double teaming Clark to try to stem the flow of goals.

Schultz drove hard into the circle and shared the scoring with Clark.

The Saints had some smooth passages of play in their attacking end but were unable to minimise Mount Burr's transition into attack as the Mozzies ran out convincing victors.

Haggett and Schultz were best for the victors, with Hayley Burner and Kylie Heaver best for the Saints.





Kalangadoo will need to limit the influence of Tantanoola shooter Emma Gould in Round 17 of Mid South East netball.

Pictures: FILE IMAGE

## 200-game milestone for Sarah

Kongorong netballer Sarah Lucas reached her 200-game milestone against Hatherleigh on the weekend.

Lucas started playing at the Kongorong Netball Club in 2006 in A Grade and played in that same grade the following year.

In 2008 she again played A Grade, winning runner-up best and fairest and representing the league at the country championships in the B Grade team.

In 2009 she has a year off to have her first child Ryan, then returned in 2010 as playing coach in the A Grade, when she claimed runner-up best and fairest.

It was also her first year on the committee.

In 2011 she again played A Grade and became president of the netball club.

Lucas took a year off in 2012 to have her second child Claire but still remained involved by filling the president's role again.

In 2013 she played A Reserve, was the records officer and joint president.

Lucas returned as A Grade playing coach in 2014, claiming most league votes and runner-up best and fairest, clocking up 100 games and filling the joint president role again.

In 2015 she was again in the A Grade team and was awarded the most consistent trophy.

Lucas continued in A Grade in 2016, winning equal most consistent and co-coaching the Under 17 girls.

In 2017 she played A Reserve and took home the runner-up best and fairest trophy, while in 2018 took on the playing coach of the A Reserve and took the team to finals, going down to Kalangadoo in the preliminary final.

She also clocked up 150 games that year.

Lucas played A Grade in 2019 and was awarded the 10 years netball club service award.

In 2021 she was a mid-season inclusion into the A Reserve team.

In 2022 Lucas returned to the A grade team down the defensive end lifting the average age of the team.

Lucas has been club person of the year three times joint in 2016 and by herself in 2018 and 2021.

She has been club secretary for the last two years and records officer for nine years.



Sarah Lucas notched up her 200-game milestone for Kongorong Netball Club on the weekend. Picture: SUBMITTED

# Round means action

### Hatherleigh v Port MacDonnell

Round 17 of Mid South East netball sees Port MacDonnell head to Hatherleigh to face off against the Eagles in what is set to be the match of the round.

There are plenty of good match ups around the court in this entertaining clash.

Hatherleigh's Chelsea Galpin, Lara MacGregor and Demi Vanderhorst have proven to be a strong defensive combination and will work hard to force turnovers in Port MacDonnell's attack line.

Port MacDonnell's Toni Gilmore and Brooke Williams combine well in goals and will need to be shut down by the Eagles defenders.

At the other end of the court the Demons' defenders Alana Winter and Belinda O'Dine will work overtime to shut down Hatherleigh goalies Maddie Redman and Abby Wight.

This game has the potential to go either way and will be one to watch.

### Robe v Mount Burr

Robe will look to cement its position in the top four when the Roosters host Mount Burr this weekend in a tough contest.

The Mozzies will look to redeem themselves after their loss to the Roosters in Round 8 and will come out firing from the first whistle.

Robe's Sarah Laurie and Halle Carter move well within their goal circle but they will have to shoot with accuracy because any rebounds and loose balls will be chased down by Mount Burr's Olivia Dean and Madi Haggett.

At the other end of the court Robe's defenders will have to work overtime to shut down the influence of Ebony Clark who is a focal point in the goal circle for the Mozzies.

Laura Schultz and Annie Hunter will have a good tussle down the court with both players working hard to create turnovers and having excellent drives onto the circle.

At the end of the game the Roosters will come away with the win, but Mount Burr will make them earn every goal.

### Tantanoola v Kalangadoo

Tantanoola hosts Kalangadoo in what is a danger game for the Tigers.

The Tigers will fight to keep their position in the top four heading into the last two weeks of the season.

Kalangadoo's Kirsty Egan will have to feed



Port MacDonnell and Hatherleigh will do battle in the Mid South East netball match of the round on Saturday.

her goalies, Kori Collins and Abbey Duncan, with accuracy through the tough hands and defensive pressure of Tigers Kate Bromley and Tayla Rowe.

Madi Kelly and Michelle Robinson will need to stop the drive from Sophie Wrightson and Kirsty Egan in an attempt to prevent the ball entering the Magpies goal circle.

Magpies Lauren Kain and Reanna Wetherall will have to shut down Tantanoola's Emma Gould and prevent her from getting too much ball within the goal circle, while also preventing Jami Walker's accurate shots.

After a hard-fought game Kalangadoo will claim the points.

### Glencoe v Kongorong

Glencoe will enter Round 17 well rested after last week's bye, ready to take on Kongorong at home.

Kongorong's defensive line up of Riley Buckingham and Emily Lightbody have the ability to create turnovers and will need to work hard to prevent goals from Glencoe's accurate shooters Malinda Markiewicz and Jenna Paproth.

Kate Wright will battle it out against Glencoe's Chloe Pfitzner on the wing and will have to feed to her goalies with accuracy around the Murphies' strong defence line up of Sarah Edwards and Chantelle Cocks.

Ashlea Edwards feeds Glencoe's goalies with accuracy from outside the circle and will be met by the pressure and strong hands of Sarah Lucas.

Glencoe's experience and defensive pressure will prove too much for the young Hawks side at the end of the day and the Murphies will come away with the points.





Millicent Gymnastics coach Fiona McDonald with Pacey Fox, Maddison Inverarity, Chloe Grosvenor, Natisha Muirhead-Rowe and Isobella Lindner in Warrnambool.



Parker Dowley on the top step of the podium in the Warrnambool competition.

Pictures: SUBMITTED



Braxton Muirhead-Rowe impressed in the Level 1 competition in Warrnambool.

The South Eastern Times

ESTABLISHED 1891

**Website:**

[www.setimes.com.au](http://www.setimes.com.au)

**CLASSIFIEDS**

**Phone:** 1300 666 808

**Email:** [sales@networkclassifieds.com.au](mailto:sales@networkclassifieds.com.au)

**ADVERTISING**

**Phone:** 08 8741 8170

**Email:** [advertising@tbwtoday.com.au](mailto:advertising@tbwtoday.com.au)

**EDITORIAL**

**Phone:** 08 8741 8170

**Email:** [editorial@tbwtoday.com.au](mailto:editorial@tbwtoday.com.au)

**DEADLINES**

**Advertising Bookings** Thursday 4pm  
(week prior)

**Classified Bookings** Tuesday 3.30pm

Level 1, 1 Commercial St East, Mount Gambier SA, 5290.

Published by TBW Today Pty Ltd.

ACN 644 311 937.

All material is copyright to TBW Today Pty Ltd.

All significant errors will be corrected as soon as possible.

Distribution numbers, areas and coverage are estimates only. For our terms and conditions, please visit

[borderwatch.com.au/terms-and-conditions](http://borderwatch.com.au/terms-and-conditions).



Proudly a South Australian company.  
Printed in South Australia.

# Poised to perform

Gymnasts from the Millicent Gymnastics Club were in action recently with competitions held in Adelaide and Warrnambool.

Pacey Fox, Maddison Inverarity, Chloe Grosvenor, Natisha Muirhead-Rowe and Isobella Lindner competed in the Women's Artistic Gymnastics Level 2 competition in Warrnambool and received two blue ribbons.

Fox and Muirhead-Rowe put in strong performances to receive three blue ribbons.

Braxton Muirhead-Rowe competed in the Men's Level 1 competition and put in an impressive display.

Muirhead-Rowe claimed the win in the Parallel Bars with a score of 9.

He was third-placed in the Floor competition and claimed fourth in the Vault, High Bars, Rings and Pommel competitions.

These consistent performances meant Muirhead-Rowe claimed third place overall in the Warrnambool.



Isobel Thompson and Savannah Dickenson competed in the Adelaide competition recently.

Parker Dowley continued his impressive run of form with a strong performance in the Level 3 competition.

Dowley won the Floor and Vault competitions with scores of 9.1 and 9.4.

He was third in the Rings competition, fourth in the High Bar, fifth in the Parallel Bars, sixth in the Pommel claimed fourth place overall.

Emily Lowndes competed in the Under 11 Women's Level 4 competition in Adelaide and placed ninth overall.

Lowndes has now been upgraded to compete in Level 5 competitions.

Savannah Dickenson competed in the Women's Under 8 Level 3 competition and claimed fourth place in the Beam competition with a score of 8.5

Isobel Thompson competed in her first Level 5 competition and competed against 21 gymnasts.

Thompson scored 8 on the Vault to claim 16th place and 8.35 on the Floor to claim 13th.

The Millicent Gymnastics club is also excited to announce it has a new foam pit to assist with the development of more difficult skills.

## Rebounding: Squash season underway

By James Murphy

Action returned to the Millicent Squash Club last night, as the 2022 Spring Pennant season commenced.

Played over 10 rounds, close results are expected again across the season.

A total of 30 players make up 10 teams, with both an A Grade and B Grade competition.

"There are 10 rounds, but the school holidays are in the middle of that, so it will be played over 12 weeks, then plus finals," Millicent Squash Club secretary Darrell Looker said.

Players range in age and ability, with a combination of young and experienced competitors.

"There is a good mixture," Looker said.

"There are some young kids play and then there are some older people who play - both boys and girls."

Looker said while sports like football, netball or basketball are always popular, squash tends to go through phases.

However, the Millicent Squash Club has always been fairly strong and stands as one of few places to play competitively in the region.

"Over the years more and more squash centres have closed down," Looker said.

"That is why I am so excited about the Millicent one, because they own the building and there are five courts there.

"They have always had a strong club."

Looker said the squash is a great way to stay fit, while also being part of a team.

He expects another competitive pennant season, with teams always weighted evenly with talent.

"Last year when we got to the final, they had won the same amount of games, but the team that won, won on points," Looker said.

"They make sure it is always going to be pretty close."

While the spring pennant competition is now locked in, Looker said new members are always welcome.

Practices are held on Monday, Wednesday and Friday nights with anyone interested encouraged to come out for a hit.

The South Eastern Times  
**DIGITAL**

**WE ARE ALL ABOUT  
OUR COMMUNITIES**

[www.setimes.com.au](http://www.setimes.com.au)







Pat Davies and Corey Barrett will meet again when Tantanoola hosts Kalangadoo on Saturday.



Hatherleigh and Port MacDonnell will go head-to-head in Round 17 of Mid South East football on Saturday. Picture: FILE IMAGE

# Eagles take it to Demons

By Trevor Jackson

## Round 17 Hatherleigh v Port MacDonnell

HATHERLEIGH faces a big test this weekend when it hosts Port MacDonnell in the penultimate minor round of Mid South East football.

The Demons have been in good touch in recent weeks as the business end of the season fast approaches.

It appears the Eagles have secured second spot on the ladder, with a big percentage advantage over the Demons but with two rounds remaining, anything is possible.

The main advantage for Hatherleigh is its depth, with the reserves undefeated to this point.

Any injuries can be covered, while the Demons are not so lucky.

Port MacDonnell lost a big list of players from the 2021 premiership side but has certainly remained relevant and in a position to defend its title.

Both sides are expected to have full lists heading into the clash, with the Eagles having

the home-ground advantage.

For the Demons, Will MacDonald and Tim Sullivan provide first use of the ball from the ruck and add valuable goal-kicking skills to their resumes.

The value of Kev Thomson cannot be understated, with his ability to take on any role, forward or back and produce the goods consistently.

Add to that the hard, at the ball efforts of the likes of Ned Wilke and Mark Smith and the Demons cannot be taken lightly, as they showed last season.

The Eagles are just as capable of scoring, with the likes of coach Jake Dowdy, Sam Telfer, Jack Skeer, Patrick Chay, Brad Mitchell - and the list goes on - all capable of hitting the scoreboard.

Big men such as Joe Ferguson-Lane and Mark Marriott can control the contest in the air, while the likes of Jed Telfer and Jason Faulkner provide a tough brand of football.

While the Eagles have the slightly better record overall this season, last time the two sides

met, back in Round 8, the Demons claimed the honours and held the Eagles to just three major scores.

This game deserves match-of-the-round billing and is sure not to disappoint.

The Eagles should claim the points but not without a fight.

## Robe v Mount Burr

While the top four positions on the ladder are all-but set, Robe has an outside chance of sneaking in.

First the Roosters need to account for Mount Burr this weekend, which will be a tall order considering the recent form of the Mozzies.

Both sides have quite winnable games in the final round, which does add some importance to this clash.

However, with the Mozzies finding form at the right time of the season, it all points to a Mount Burr victory.

## Glencoe v Kongorong

Only pride is on the line when Glencoe and

Kongorong face off at the Murphies home ground.

The Hawks have played some patches of good football this season, while Glencoe has been in good form in recent weeks, with a good run up to last round's bye.

The Murphies should take care of this one without too many dramas, despite a tough challenge around the ground from the Hawks.

## Tantanoola v Kalangadoo

Tantanoola faces an unenviable task of hosting Kalangadoo, with the Magpies simply going from form strength to strength as the season winds down.

The biggest talking point will be how many goal Michael Krieger can kick by the final round.

He currently sits on 73 with two rounds to play but will face a tough Hatherleigh in the final minor round.

The Magpies will romp away with this one and continue to fine tune as finals action fast approaches.

## Langley set to reach milestone

This weekend, Dave Langley will take to the field for his 150th game for Tantanoola.

Langley is a left-footer with a huge heart, who always puts the team first.

He has spent his entire career playing for the Tigers and is always willing to help out around the club.

Langley's first trophy came in 2004 in the Junior Cults, when he took home the most-improved and in 2008, he ran onto the field for his first senior appearance.

In 2010, he won the B Grade coach's trophy and in 2017 and 2018, he had strong seasons and won the best team man award.



Dave Langley in action for Tantanoola.

Picture: NAOMI MORELAND





# Saints outrun Demons

By James Murphy

**MILLICENT 13.11 (89) d  
SOUTH GAMBIER 6.8 (44)**

In a preview of the coming qualifying final, Western Border football ladder leaders South Gambier and Millicent clashed at Blue Lake Sports Park on Saturday.

With mixed results from their previous clashes, it was the Saints who prevailed on the weekend to level their head-to-head record at two wins each this season.

As the final minor round and with no impact on the ladder, the Round 16 fixture was somewhat of a dead rubber across the board.

However, a game remained to be won and Millicent led at every change on its way to a 45-point victory.

"We had a plan during the week to win a game of footy and we did," Millicent coach Clint Gallio said.

"We had some really good patches of play and that was really pleasing."

Dylan Bromley had another day out in front of goals, with seven majors, while Thomas Hutchesson also popped up with a couple.

The opening quarter was relatively even and Gallio said he felt the Demons probably had more control over the game during that period.

Despite that, Millicent held an eight-point advantage at the first change, before a lift in the second term gave the Saints the upper hand.

"We chatted about a few things at quarter time and fixed up a few things and swung the momentum our way a bit," Gallio said.

"We had some really good looks forward and some isolation up there."

"Our defenders always have a crack and they are really good for us every week."

"They repelled a lot of balls and then we controlled the ball through the middle."

"After that 10-minute mark of the second quarter it felt like we controlled the game a little bit which was pleasing."

Sam Willis was part of the midfield group and he put in a best-on-ground performance for the Saints.

He has been in a purple patch of form in recent rounds and has found his groove at the right end of the season.

"He played really well and got a lot of the footy," Gallio said.

A six-goal-to-one return in the second term set up a six-goal lead at half time and from there the Saints remained on top for the re-



Millicent's Noah Lang runs the ball through heavy traffic during the Saints' win over South Gambier on Saturday.

Pictures: TREVOR JACKSON

mainder of the match.

Willis was not the only young talent to earn a mention, with Jaxon Cushion and Jacob Todd sharing the ruck duties once again in the absence of Sam Waring and Finn Grimes.

"We used both of those boys in the ruck again and we thought they did an outstanding job for us," Gallio said.

"They did a super job for us against Mason (Hein) who is a big boy and probably one of the better rucks in the league."

South was best served by Brock Keding on the day, who has enjoyed a fruitful season so far.

His work through the midfield was impressive, while the backline also received high praise on the day.

The likes of Taylor Saffin, Todd Reid, James Paprotny and Chris Fallas were all in fine form.

While Saturday's clash did nothing to ladder position, the Demons will be eager to bounce back in a big way when they face the Saints again in the second semi-final in a couple of weeks.

In a rare occurrence for South, there were no key targets in the forward line and all six goals came off a different boot.

Both teams will now hit the training track hard in preparation for their next meeting, which will reward the victor with the first place in the 2022 grand final.



Dylan Bromley bagged seven goals for Millicent in its win over South Gambier on Saturday.

## Saints pushed by Demons

**MILLICENT 59 d SOUTH GAMBIER 54**

Millicent held off a tenacious South Gambier on Saturday to deny the Demons a breakthrough finals appearance.

The final margin was five goals with South within two at one stage in the frenetic final quarter.

Despite being a loss it was a strong finish to the season for the young line-up, who picked up six wins for the season to double its 2021 output.

However, in the end the Saints were composed when it counted, despite losing star wing defender Georgia Clarke to a serious knee injury in the opening quarter.

Demi Verbena and Lisa Duldig led the way as they controlled the ball movement in the attacking half of the court.

They worked well in tandem with Paige Nitschke and delivered with precision to Tabatha Sanderson under the post.

At the other end the battle was intriguing as four of the best young stars in the competition went head to head. Millicent defenders Portia McRae and Hannah Nitschke took on Demons goalers Lara Munro and Alyssa Duncan in a tight tussle.

Millicent would be pleased to have been challenged strongly ahead of its 2022 finals campaign.

The Saints' depth was on full display with Lillie Paul taking the wing defence bib to replace the injured Clarke and having a great battle with Tully McShane.

They now enter a break as Western Border netball finals start this weekend, with the elimination final between East Gambier and North Gambier opening proceedings.

They will play West Gambier in two week's time in the qualifying final, which will be a big indication of who may be the 2022 champions.



Millicent's Lisa Duldig proved a hard match through the Saints' midcourt during their tight win over South Gambier on Saturday.  
Picture: FILE IMAGE